



Product Brochure

the
sanitaryware
company

Quality sanitaryware, always at great value



■	About Us	02
■	SanCeram	04
■	Hand Picked Partners	06
■	Industry Approvals	07
■	WCs	08
■	Cisterns	26
■	Your Dedicated Online Resource	37
■	Urinals	38
■	Online Trade Accounts	47
■	Hand Wash Basins	48
■	Brassware	62
■	Case Studies	81
■	Doc M	82
■	HBN Compliant Healthcare	96
■	Showers	106
■	Accessories	130
■	Why Choose SanCeram	136
■	How can we help?	137

How to get in touch...

Call us on 01474 338300

Email us on sales@theswc.co.uk

www.theswc.co.uk



Click the button to find out more about The Sanitaryware Company and purchase online

As market leaders in commercial sanitaryware, we pride ourselves in delivering the very best products in terms of value and performance, with service that is second to none.

With products available for all sectors, our experienced technical experts will ensure that we offer the right solution for every environment, every time. We are competitively priced and our passion for providing the very best service is what sets us apart.

Service

With over 100 year's washroom knowledge we know how to make your life as easy as possible when it comes to ordering your sanitaryware items. We can talk you through the most suitable products for your project, ensure compliance and write bespoke specification documents. We can also provide 2D CAD Blocks, BIM, Product Data Sheets and NBS Documents. We will ensure we meet any tender return dates when providing quotations and our internal sales team are able to offer a variety of options including value engineered alternatives when required.

Quality Products

We have partnered with hand-picked manufactures who share our vision for supplying the highest quality sanitaryware. We are also proud to offer our in-house brand SanCeram, which offers surprising affordability while still being compliant and stylish. The confidence in our products is reflected in the warranties that we provide.

Delivery

We offer fast and efficient delivery on all of our standard products and free delivery on all orders over £500. If required we can phase your project, delivering items to site as and when you need them.

Website

All of our products are available to buy on our easy to use, secure website, with our expert team just a click away on our LiveChat facility. All stocked items are available for speedy delivery. You can order and pay on your Trade Account and manage your account and on-site delivery addresses. You will also have access to our Technical Library where you can download and save technical documents to your personal project folders.



Click the button to find out more about The Sanitaryware Company

Products to suit every sector:



Commercial: Installed at Mettler Toledo Safeline



Education: Installed at Broom Valley Community School



Leisure: Installed at Dover Castle



Healthcare: Installed at Acre Mills Hospital



Travel: Installed at Merthyr Tydfil Bus Station



Residential: Installed at Derwent Walk



We have complete confidence in all our products, so much so we offer the following warranties:



25 Year Warranty
On ceramic products



5 – 20 Year Warranty
On brassware and showers



2 Year Warranty
On sensor taps



1 Year Warranty
On cisterns



1 Year Warranty
On seats

Please note: All warranties are subject to manufactures terms and are install and environment dependant.

SanCeram has been developed utilising our extensive knowledge and understanding of the washroom industry.

SanCeram

The SanCeram ethos is to offer our customer's high quality sanitaryware to suit all sectors and budgets. The collection offers surprising affordability and boasts modern and stylish designs that are purpose built to allow for easy cleaning and maintenance.

With products available for all applications ensuring compliances are met, we are confident that SanCeram will exceed your requirements and expectations.

The SanCeram Promise

Quality Guarantee

We promise to bring our customers the very best products in the market place. That's why we are confident to offer a 25 year warranty on all our ceramics.

Extensive Product Range

Our breadth of range is extraordinary. Whatever the project, whatever the space, we have a product that fits, perfectly.

Surprisingly Affordable

We don't believe in nasty surprises. With SanCeram you have our word that quality and style won't cost you a fortune.

Unrivalled Support

Our team of experts are on hand to help you every step of the way. From choosing the right product, through to technical and installation queries, we are only a call or email away.

Environmentally Friendly

We are dedicated to preserving our planet. The SanCeram range is manufactured using eco-friendly methods and our water saving products will help toward earning BREEAM credits.

Products to suit every sector:



Commercial: Installed at a Richmond Magistrates Court



Education: Installed at Manchester Secondary School



Leisure: Installed at Consall Hall Gardens



Healthcare: Installed at Nelson Hospital



Residential: Installed at Mulberry House



Why choose SanCeram?



Cost Effective
Savings of up to 40%



Approved & Certified
SanCeram contains HBN, DDA, WRAS approved and LABC certified products



25 Year Warranty
Our ceramics come with a 25 year warranty



Contemporary Styling
Inspired, modern designs without compromising on quality



Speedy Delivery
Fast and efficient delivery, stocked items delivered within 48 hours



Click the button to learn more about our SanCeram range



Armitage Shanks and Ideal Standard – Armitage Shanks are a leader in the healthcare market and their products can also be found in office washrooms as well as leisure centres, schools and hotels.

As well as being the name of their parent company, Ideal Standard is one of the leading domestic bathroom brands in the UK. They are renowned for the exceptional quality of their products and an unceasing desire to constantly push the boundaries of design and technology.



Inta – Inta’s anti-scald agenda and commitment to energy efficient products has positioned them at the forefront of bathroom innovation. They offer one of the widest and most diverse tap and shower collections on the market.



TMV – Thermostatic Mixing Valves (TMV) control water temperature by mixing hot and cold water together to ensure constant and safe water outlet temperatures, preventing scalding.

TMV3’s adhere to the NHS D08 regulatory standard, are HBN/SHTM compliant and comply with Doc M regulations. TMV3’s are suitable for use in healthcare and education sanitaryware settings as well as general commercial use. TMV2 tend to be most used in domestic environments.



HBN/SHTM

Health Building Notes (HBN) – Give ‘best practice’ guidance on the design and planning of new healthcare buildings and on the adaptation / extension of existing facilities. They provide information to support the briefing and design processes for individual projects in the NHS building programme.

In Scotland the Scottish Health Technical Memorandum (SHTM) gives comprehensive advice and guidance on the design, installation and operation of specialised building and engineering technology used in the delivery of healthcare.



KWC DVS – Formerly known as Franke Sissons and Dart Valley Systems, KWC DVS are leaders in automatic washroom technology and commercial sanitaryware. Providing one solution to some of the most demanding environments, including high security healthcare, custodial, retail, leisure, education, airports and other public and semi-public washrooms.



Methven – World renowned for creating beautifully designed, award winning showers, taps and valves since 1886. They pride themselves on spending a great deal of time and effort on research and development to improve on conventional hardware solutions. The Deva range provides a wide variety of products for both domestic and commercial applications.



Doc M

Doc M – Document M of the building regulations delivers guidance on providing access to and the use of buildings for disabled people. It helps ensure compliance for washroom facilities regardless of the nature of the building.

In conjunction with the Equality Act (updated 2010), which requires that every business providing goods or services to the public must take reasonable steps to ensure disabled people are not at a disadvantage, compared to non-disabled people when accessing all aspects of their premises, in short it gives ‘access for all’.

For further information please see page 82.



BREEAM (BRE Environmental Assessment Method) – Is the leading and most widely used environmental assessment method for buildings. It sets the standard for best practice in sustainable design and has become the go to measure used to describe a building’s environmental performance. This is a measure for a project as a whole and not individual products, but water efficiency can contribute to around 7% of the total rating.



Merlyn – The number one supplier of showering enclosures, shower trays and bath screens in the UK and Ireland, serving residential, commercial and hospitality sectors. Their meticulous attention to detail is rivalled only by their passion and commitment to flawless design and the use of the finest materials.

Tyde – Thomas Dudley and Masefield Beta have always had a reputation for delivering top quality products and value-adding solutions. Now, as TYDE, they are combining their resources to deliver high end bathroom products and quality cast iron components. All TYDE concealed WC cisterns have been fully tested to the highest standards with SanCeram WC pans.



WRAS – The Water Regulations Approval Scheme (WRAS) is an independent UK certification body for plumbing products and materials, helping businesses and consumers choose compliant products that keep water safe. A WRAS approval is an easy way to demonstrate that a material or water fitting is of a suitable quality and high standard, set out by water regulations.



Riba CPD Providers Network – Consisting of over 500 manufacturers and suppliers, training companies and advisory organisations, The RIBA CPD Providers Network provide RIBA approved CPD’s to architects and other specifiers. Our Riba approved CPD’s fit into the Legal, Regulatory and Statutory Compliance and Design, Construction and Technology Riba core curriculum topics. You can take part in our CPD’s online, or we can present to your team in person or remotely.

Our collection of sleek and modern WCs include Back to Wall, Wall Hung and Close Coupled designs, as well as hygienic Rimless options and WCs that comply with DOC M and HBN regulations.

Whatever type of WC you require, whether it's for a commercial or a school washroom, you will find a suitable design at the right price to suit your budget. To complement our range of WCs we also have a complete range of toilet seats, cisterns and flushing controls.

Wall Hung WCs

Our range of Wall Hung WCs are perfect if you're looking for an ultra-modern, minimalist and space saving WC. With designs from SanCeram, Ideal Standard and Armitage Shanks, our collection of wall mounted WCs have smooth, clean lines. Hidden fixations provide a seamless finish and with features such as ergonomic design and easy clean floor space, Wall Hung WCs are a great solution where space is minimal or narrow.

Back to Wall WCs

Sat on the floor, Back to Wall WCs are strong and secure, ideal for demanding environments. Our range include features such as box flushing rim and easy-clean designs. We also have Doc M compliant options for disabled and accessible toilet use.

Close Coupled WCs

Our Close Coupled WCs are brought to you by SanCeram and Armitage Shanks, offering designs that are sleek and modern with robust precision casting. All of our Close Coupled WCs have an ultra slim cistern with a 6/3ltr dual flush to promote water saving, great for when budget and space are tight.

Disabled Toilets

Our range of Disabled Toilets are Doc M compliant and perfect for wheelchair access in commercial, education, leisure and retail settings offering both raised height and extended projection. If you are looking for a full Doc M solution then our Doc M WC packs can be found on page 82.

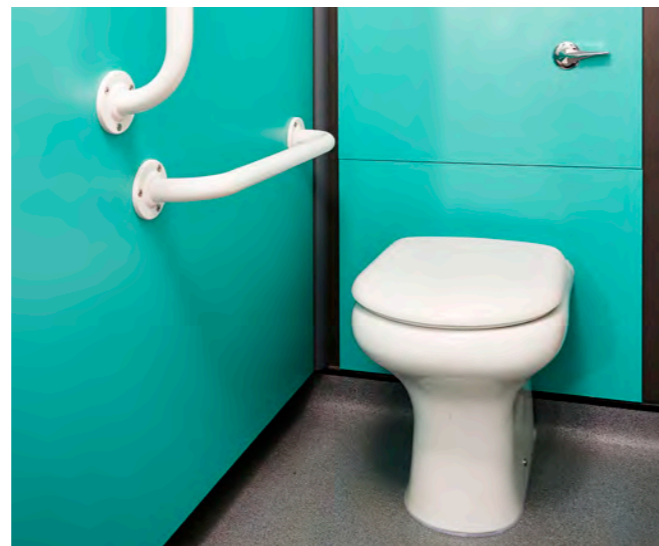

Icon key – Features of our products



We are proud to offer a wide range of Rimless WCs that set new standards in hygiene and water saving.

- ✔ **Hygienic and easy to clean:** The water closets have no rims to harbour germs, making cleaning quick, easy and more hygienic
- ✔ **Water saving:** Using just 4 litres for the full flush and 2.5 litres for the half flush, water usage is reduced by a third
- ✔ **Efficient design:** Design and efficiency can be successfully combined. Water flows vertically and horizontally, before flushing the entire inner surface of the bowl, without splashing
- ✔ **Silent flush:** Rimless technology allows a faster and more silent flush

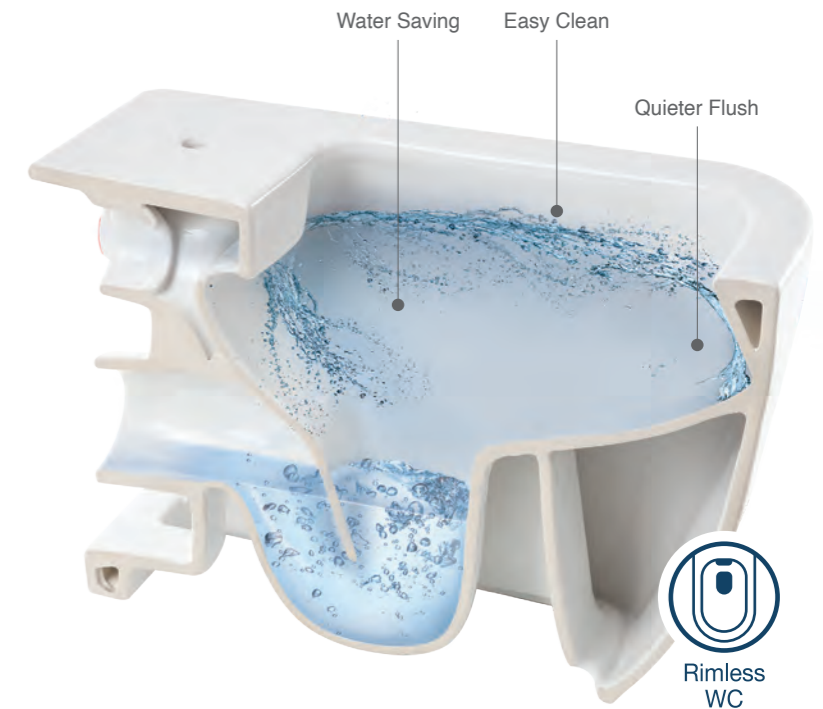

We recommend...

Early years education

Our SanCeram Shenley Back to Wall Toilet Pan measures 350mm high from the floor to the rim making it an ideal height for early years, encouraging and supporting independent use.

Commercial

Our SanCeram Langley Curve Wall Hung Toilet Pan is stylish and modern providing the wow factor, with a rimless design for ultimate hygiene control.

Best all-rounder

Our SanCeram Chartham Back to Wall Toilet Pan is suitable for all sectors from education to leisure. With a sleek, clean and strong design it will fit into any washroom environment and budget.

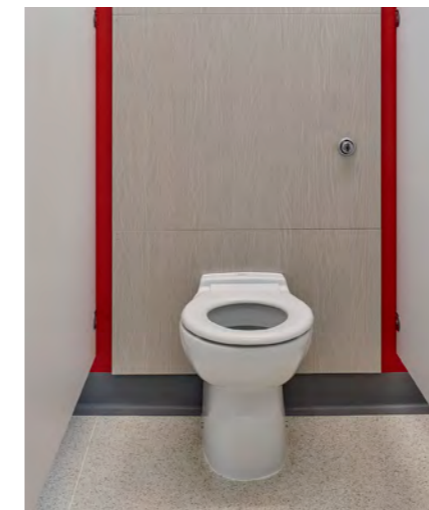

Installed at: Broom Valley School



Installed at: Mettler Toledo Safeline



Installed at: Merthyr Tydfil Bus Station

Chartham Close Coupled Toilet Pack
CHWC108



SanCeram



Our SanCeram Chartham Close Coupled Toilet Pack includes 6/3ltr dual flush push button cistern for water saving in one convenient pack.

Features & Benefits

- 3.75ltr effective flush volume
- Sleek easy to clean design
- Open rim design
- Standard height and projection pan
- Cistern and seat included

Fixing

- Supplied with floor fixing pack

Material

- Vitreous china to BS 3402

Flushing

- Supplied with 6/3ltr push button dual flush close coupled cistern

Seat Options

- Supplied with Chartham soft close seat and cover in white

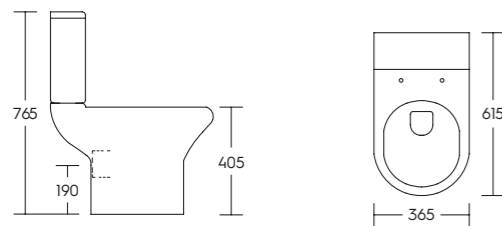

Sandringham 21 Close Coupled Toilet Pan with Horizontal Outlet E896301



Armitage Shanks



Armitage Shanks Sandringham 21 Close Coupled Toilet Pan with horizontal outlet, compatible for use with the Sandringham 21 Close Coupled Cistern.

Features & Benefits

- Hard-wearing, robust WC suite
- Standard height, 400mm from floor to rim
- Standard projection pan
- Cistern and seat sold separately

Fixing

- Domex screws – S910101

Material

- Vitreous china to BS 3402

Flushing

- Compatible with Sandringham 21 close coupled cistern 4/2.6ltr push button dual flush – E896701
- Compatible with Sandringham 21 close coupled cistern 6/4ltr push button dual flush – E896601

Seat Options

- Sandringham seat and cover in white – E131601
- Sandringham seat and cover, metal hinges in white – E131701
- Sandringham seat only, metal hinges in white – E131901

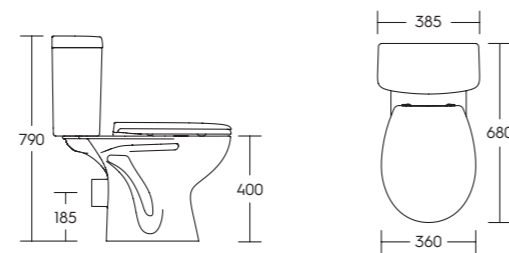

Chartham Beyond Rimless Close Coupled Toilet Pack CHWC123



SanCeram



Our SanCeram Chartham Beyond Rimless Close Coupled Toilet Pack includes 6/4ltr dual flush push button cistern in one convenient pack.

Features & Benefits

- 4.5ltr effective flush volume
- Rimless design for optimum hygiene, ease of cleaning and water saving
- Standard height and projection pan
- Cistern and seat included

Fixing

- Supplied with floor fixing pack

Material

- Vitreous china to BS 3402

Flushing

- Supplied with 6/4ltr push button dual flush close coupled cistern

Seat Options

- Supplied with Chartham soft close seat and cover in white

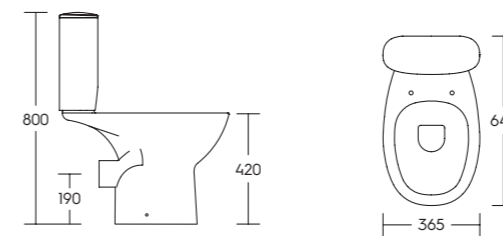

Langley Closed Coupled Toilet Pack LLWC106



SanCeram



Our SanCeram Langley Close Coupled Toilet Pack including 6/3ltr dual flush push button cistern has a rimless flush design for optimum hygiene, ease of cleaning and water saving.

Features & Benefits

- 3.75ltr effective flush volume
- Rimless design for optimum hygiene, ease of cleaning and water saving
- Standard height and projection pan
- Cistern and seat included

Fixing

- Supplied with floor fixing pack

Material

- Vitreous china to BS 3402

Flushing

- Supplied with 6/3ltr push button dual flush close coupled cistern

Seat Options

- Supplied with Langley soft close seat and cover in white

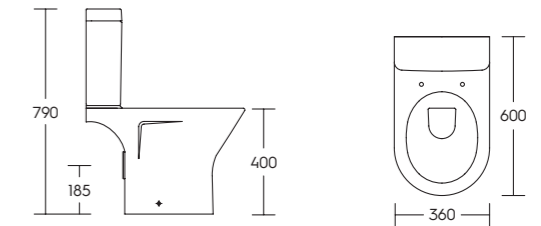

Chartham Back to Wall Toilet Pan
CHWC102



SanCeram

Our SanCeram Chartham Back to Wall Toilet Pan is a great all-rounder suitable for all sectors. With a sleek, clean and strong design it will fit into any washroom environment.

Features & Benefits

- Durable, robust modern style
- Sleek smooth lines giving dirt nowhere to hide
- Open rim design
- Seat sold separately

Fixing

- Supplied with floor fixing pack

Material

- Vitreous china to BS 3402

Flushing

- Compatible with OSMO® T1 concealed cistern – CIST200

Seat Options

- Chartham standard seat and cover in white – CHWC109
- Chartham soft close seat and cover in white – CHWC110

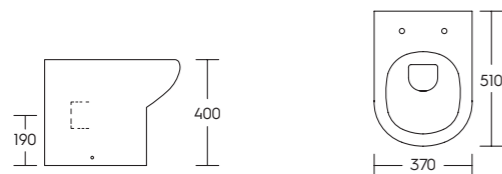

Sandringham 21 Back to Wall Toilet Pan E897401



Armitage Shanks

Armitage Shanks Sandringham 21 Back to Wall Toilet Pan is ideal for commercial washrooms offering quality, reliability and simplicity.

Features & Benefits

- Open rim design
- Standard height and projection
- Seat and fixing sold separately

Fixing

- Domex screws – S910101

Material

- Vitreous china to BS 3402

Flushing

- Compatible with OSMO® T1 concealed cistern – CIST200

Seat Options

- Sandringham seat and cover in white – E131601
- Sandringham 21 seat and cover with metal hinges in white – E131701
- Sandringham 21 seat only with metal hinges in white – E131901

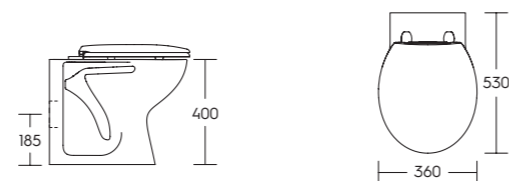

Chartham Beyond Back to Wall Rimless Toilet Pan CHWC121



SanCeram



Our SanCeram Chartham Beyond Back to Wall Rimless Toilet Pan has a clean and sleek design that will fit into any commercial washroom, with the added benefit of rimless technology using less water.

Features & Benefits

- Rimless design for optimum hygiene and water saving
- Easy clean design
- Comfort height and standard projection pan
- Seat sold separately

Fixing

- Supplied with floor fixing pack

Material

- Vitreous china to BS 3402

Flushing

- Compatible with OSMO® T1 concealed cistern – CIST200

Seat Options

- Chartham Beyond slim soft close seat and cover in white – CHWC124
- Chartham Beyond slim standard close seat and cover in white – CHWC125

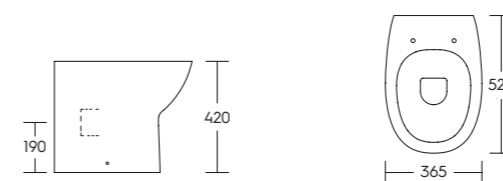

Chartham 450 Back to Wall Rimless Toilet Pan CHWC103



SanCeram



Our SanCeram Chartham Rimless 450 Back to Wall Toilet Pan sits at comfort height – 450mm from floor to top of seat.

Features & Benefits

- Rimless design for optimum hygiene and water saving
- Sleek easy to clean style
- Comfort height and standard projection pan
- Seat sold separately

Fixing

- Supplied with floor fixing pack

Material

- Vitreous china to BS 3402

Flushing

- Compatible with OSMO® T1 concealed cistern – CIST200

Seat Options

- Chartham rimless soft close seat and cover in white – CHWC111
- Chartham seat only in white – CHWC112
- Chartham seat only in blue – CHWC113
- Chartham seat only in dark grey – CHWC114

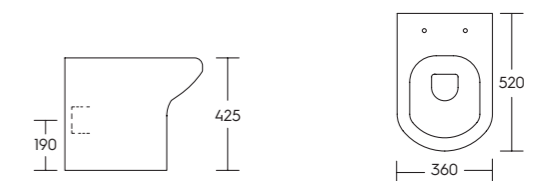

Contour 21+ Back to Wall Rimless Toilet Pan S0439HY



Armitage Shanks



Armitage Shanks Contour 21+ Back to Wall Rimless Toilet Pan features a rimless design and antimicrobial surfaces for increased hygiene.

Features & Benefits

- Rimless design for ease of cleaning and water saving
- Hydrophilic glaze with anti-microbial properties
- Raised outlet for multiple installations
- Comfort height and standard projection pan
- Seat sold separately

Fixing

- Supplied with floor fixing pack

Material

- Vitreous china to BS 3402

Flushing

- Compatible with OSMO® T1 concealed cistern – CIST200

Seat Options

- Contour 21 seat only with retaining buffers in:
- White – S406601
 - Blue – S406636
 - Grey – S4066LJ
 - Charcoal – S4066RN
 - Red – S4066GQ
- Contour 21 seat and cover with top fixing hinges in white – S406501
 - Contour 21 seat and cover, slim slow close in white – S067001

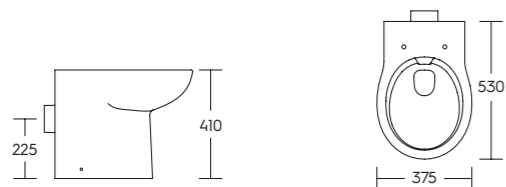

Langley Back to Wall Rimless Toilet Pan LLWC102



SanCeram



Our SanCeram Langley Rimless Back to Wall Toilet Pan offers a stylish hygienic WC that will fit nicely into any modern washroom.

Features & Benefits

- Rimless design for optimum hygiene and water saving
- Minimalistic design allowing for easy cleaning and maintenance
- Standard height and projection pan
- Seat sold separately

Fixing

- Supplied with floor fixing pack

Material

- Vitreous china to BS 3402

Flushing

- Compatible with OSMO® T1 concealed cistern – CIST200

Seat Options

- Langley soft close seat and cover in white – LLWC105
- Langley slim soft close seat and cover in white – LLWC107

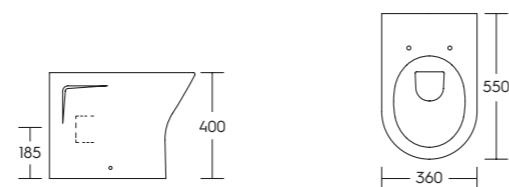

Langley Curve Back to Wall Rimless Toilet Pan LLWC122



SanCeram



Our stylish SanCeram Langley Curve Back to Wall Rimless Toilet Pan has a rimless design for optimum hygiene, ease of cleaning and water saving.

Features & Benefits

- Modern contemporary design
- Rimless design for optimum hygiene
- Standard height and projection pan
- Seat sold separately

Fixing

- Supplied with floor fixing pack

Material

- Vitreous china to BS 3402

Flushing

- Compatible with OSMO® T1 concealed cistern – CIST200

Seat Options

- Langley Curve slim soft close seat and cover in white – LLWC124

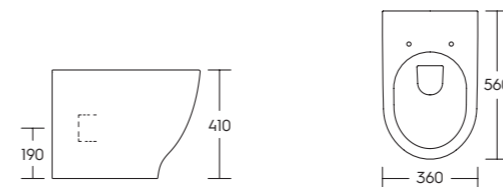

Concept Back to Wall Toilet Pan E050901



Ideal Standard



Ideal Standard Concept Back to Wall Toilet Pan with Aquablade rimless flush gives exceptional performance, hygiene and easy cleaning.

Features & Benefits

- Smooth modern design
- Rimless Aquablade flush technology
- Standard height and projection pan
- Seat sold separately

Fixing

- Supplied with floor fixing pack

Material

- Vitreous china to BS 3402

Flushing

- Compatible with OSMO® T1 concealed cistern – CIST200

Seat Options

- Concept slim soft close seat and cover in white – E772601

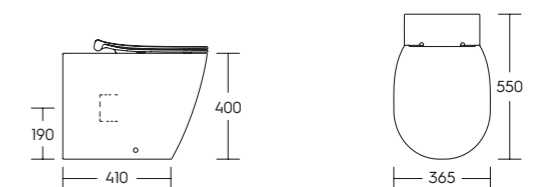

Shenley School Back to Wall 350 Toilet Pan SHWC101



SanCeram



Early Years

Our SanCeram Shenley Back to Wall 350 Toilet Pan is the ideal height for young children, to encourage and support independent use.

Features & Benefits

- Low height, 350mm from floor to rim
- Ideal for use in early years education settings
- Sleek smooth lines allow for easy cleaning with nowhere for dirt to hide
- Seat sold separately

Fixing

- Supplied with floor fixing pack

Material

- Vitreous china to BS 3402

Flushing

- Compatible with OSMO® T1 concealed cistern – CIST200

Seat Options

- For use with Shenley seat only in white – SHWC102

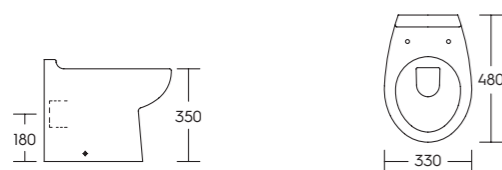

Contour 21 Schools 305mm Back To Wall Toilet S304601



Armitage Shanks



Early Years

Armitage Shanks Contour 21 Schools 305mm high Back to Wall Toilet Pan with horizontal outlet is ideal as a preschool toilet for young children.

Features & Benefits

- Low height of 305mm
- Open rim design
- Seat sold separately
- Suitable for back to wall or close coupled installation

Fixing

- Domex screws – S910101 for close coupled installation

Material

- Vitreous china to BS 3402

Flushing

- Compatible with Contour 21 schools close coupled push button 6/4ltr cistern – S306401
- Compatible with Contour 21 schools close coupled lever flush 4.5ltr cistern – S369601
- Compatible with OSMO® T1 concealed cistern – CIST200

Seat Options

Contour 21 seat only for 305mm high pan:

- White – S405701
- Blue – S405736
- Black – S405766
- Red – S4057GQ
- Grey – S4057LJ
- Contour 21 seat and cover for 305mm high pan in white – S405601

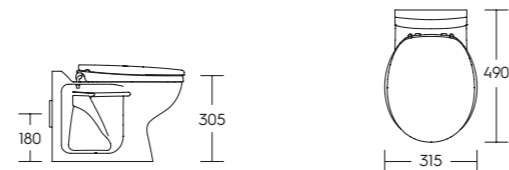

Contour 21 Schools 355mm Back To Wall Toilet Pan S304701



Armitage Shanks



Early Years

Armitage Shanks Contour 21 Schools 355mm high Back to Wall and Close Coupled Toilet Pan with horizontal outlet, ideal for young children.

Features & Benefits

- Low height of 355mm
- Open rim design
- Seat sold separately
- Suitable for back to wall or close coupled installation

Fixing

- Supplied with floor fixing pack for back to wall installation

Material

- Vitreous china to BS 3402

Flushing

- Compatible with Contour 21 schools close coupled push button 6/4ltr cistern – S306401
- Compatible with Contour 21 schools close coupled lever flush 4.5ltr cistern – S369601
- Compatible with OSMO® T1 concealed cistern – CIST200

Seat Options

Contour 21 seat only for 355mm high toilet pan:

- White – S405901
- Blue – S405936
- Black – S405966
- Red – S4059GQ
- Grey – S4059LJ
- Contour 21 seat and cover for 355mm high toilet pans in white – S405801

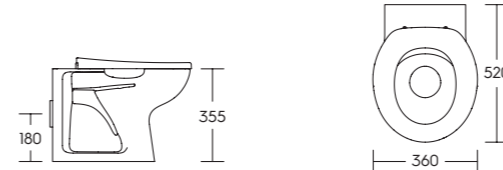

Chartham Wall Hung Toilet Pan CHWC101



SanCeram

Our SanCeram Chartham Wall Hung Toilet Pan is a great all rounder WC suitable for all sectors. With a clean and sleek design it will fit into any washroom environment.

Features & Benefits

- Shorter projection ideal for smaller spaces
- Wall hung installation reduces dirt traps
- Seat sold separately

Fixing

- Support brackets and fixings – TSWC117*

Material

- Vitreous china to BS 3402

Flushing

- Compatible with OSMO® T1 concealed cistern – CIST200
- Compatible with WC in wall support frame with dual flush cistern – CIST114

Seat Options

- Chartham standard seat and cover in white – CHWC109
- Chartham soft close seat and cover in white – CHWC110

*Not required if installed with WC support frames

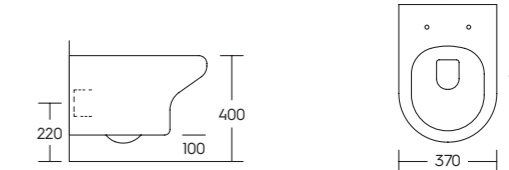

Sandringham 21 Wall Hung Toilet Pan V391001



Armitage Shanks



Armitage Shanks Sandringham 21 Wall Hung Toilet Pan is a simple, contemporary designed WC suitable for a multitude of environments.

Features & Benefits

- Water efficient
- Open rim design
- Wall hung installation reduces dirt traps
- Seat sold separately

Fixing

- Support brackets and bolts – E006067

Material

- Vitreous china to BS 3402

Flushing

- Compatible with OSMO® T1 concealed cistern – CIST200

Seat Options

- Sandringham seat and cover in white – E131601
- Sandringham seat and cover with metal hinges in white – E13170
- Sandringham seat only with metal hinges in white – E131901

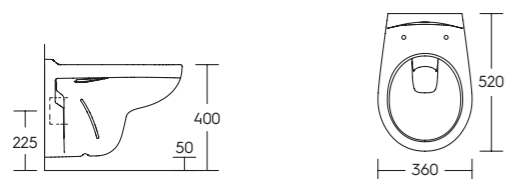

Chartham Beyond Wall Hung Rimless Toilet Pan CHWC122



SanCeram



Our SanCeram Chartham Beyond Wall Hung Toilet Pan has a clean and sleek design that will fit into any washroom environment, with the added hygiene benefits that a rimless flush offers.

Features & Benefits

- Rimless design for optimum hygiene, ease of cleaning and water saving
- Wall hung installation reduces dirt traps
- Seat sold separately

Fixing

- Support brackets and fixings – TSWC117*

Material

- Vitreous china to BS 3402

Flushing

- Compatible with OSMO® T1 concealed cistern – CIST200
- WC in wall support frame with dual flush cistern – CIST114

Seat Options

- Chartham Beyond slim soft close seat and cover in white – CHWC124
- Chartham Beyond slim standard close seat and cover in white – CHWC125

*Not required if installed with WC support frames.

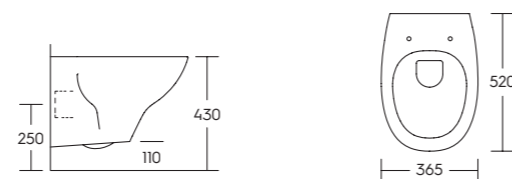

Langley Wall Hung Rimless Toilet Pan LLWC101



SanCeram



Our SanCeram Langley Wall Hung Toilet Pan is beautifully styled, with the innovative rimless design making this a perfect pick for any washroom project.

Features & Benefits

- Rimless design for optimum hygiene, ease of cleaning and water saving
- Wall hung installation reduces dirt traps
- Seat sold separately

Fixing

- Support brackets and fixings – TSWC117*

Material

- Vitreous china to BS 3402

Flushing

- Compatible with OSMO® T1 concealed cistern – CIST200
- WC in wall support frame with dual flush cistern – CIST114

Seat Options

- Langley soft close seat and cover in white – LLWC105
- Langley slim soft close seat and cover in white – LLWC107

*Not required if installed with WC support frames.

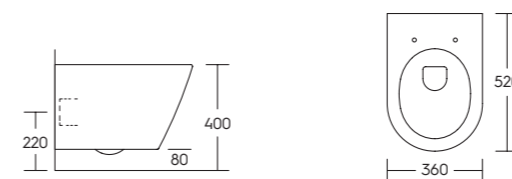

Langley Curve Wall Hung Toilet Pan LLWC121



SanCeram



Our SanCeram Langley Curve Wall Hung Toilet Pan has a rimless flush design for ultimate hygiene, ease of cleaning and water saving.

Features & Benefits

- Simple one-person, time-saving installation
- Completely hidden fixation – ceramic design is not compromised with fixing point
- Wall hung installation reduces dirt traps
- Seat sold separately

Fixing

- Support brackets and fixings – TSWC117*

Material

- Vitreous china to BS 3402

Flushing

- Compatible with OSMO® T1 concealed cistern – CIST200
- WC in wall support frame with dual flush cistern – CIST114

Seat Options

- Langley Curve soft close seat and cover in white – LLWC124

*Not required if installed with WC support frames.

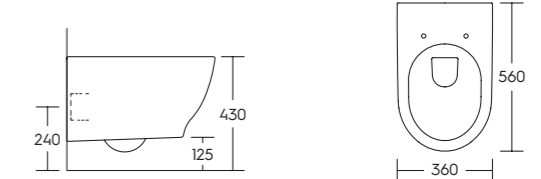

Concept Wall Hung Toilet Pan
E047301



Ideal Standard



Ideal Standard Concept Wall Hung Toilet Pan with innovative flushing technology giving exceptional performance, hygiene and easy cleaning.

Features & Benefits

- Rimless Aquablade flush design
- Hidden fixation system
- Standard projection pan
- Seat sold separately

Fixing

- Support brackets and bolts – E006067

Material

- Vitreous china to BS 3402

Flushing

- Compatible with OSMO® T1 concealed cistern – CIST200

Seat Options

- Concept slim soft close seat and cover in white – E772601
- Concept slim standard close seat and cover in white – E772501
- Concept soft close seat and cover in white – E791701
- Concept standard close seat and cover in white – E791801

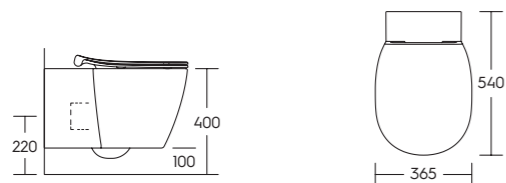

Chartham Close Coupled 750 Projection Toilet Pan with Cistern CHWC107



SanCeram



Our SanCeram Chartham Rimless Close Coupled Toilet Pan comes complete with close coupled 6/3ltr dual flush lever action cistern. With extended projection to 750mm it has the added benefit of being Doc M compliant.

Features & Benefits

- 3.75ltr effective flush volume
- Rimless design for optimum hygiene, ease of cleaning and water saving
- Raised height 480mm from floor to top of seat
- Extended projection
- Seat sold separately

Fixing

- Supplied with floor fixing pack

Material

- Vitreous china to BS 3402

Flushing

- Supplied with 6/3ltr dual flush close coupled cistern

Seat Options

- Chartham seat only in white – CHWC112
- Chartham seat only in blue – CHWC113
- Chartham seat only in dark grey – CHWC114

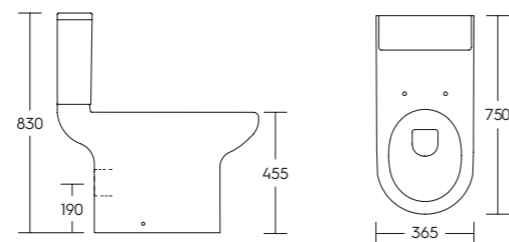

Contour 21 Raised Height Close Coupled Toilet Pan S305401



Armitage Shanks



Armitage Shanks Contour 21 Raised Height Close Coupled Toilet Pan with horizontal outlet and 750mm projection is Doc M compliant.

Features & Benefits

- Water efficient
- Box rim design
- Raised height, 480mm from floor to top of seat
- Extended projection
- Seat sold separately
- Cistern sold separately

Fixing

- Supplied with floor fixing pack

Material

- Vitreous china to BS 3402

Flushing

- Compatible with Contour 21 close coupled WC cistern 4.5l with spatula lever – S365401

Seat Options

- Contour 21 seat only with retaining buffers in:
- White – S406601
 - Blue – S406636
 - Grey – S4066LJ
 - Charcoal – S4066RN
 - Red – S4066GQ
- Contour 21 seat and cover with top fixing hinges in:
- White – S406501
 - Blue – S406536
 - Grey – S4065LJ
 - Charcoal – S4065RN

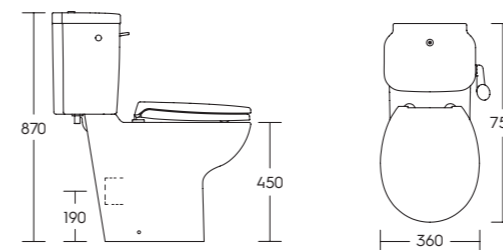

Chartham Back to Wall 750 Projection Rimless Toilet Pan CHWC106



SanCeram



Our SanCeram Chartham Rimless Back to Wall Toilet Pan has extended projection to 750mm for Doc M compliance.

Features & Benefits

- Rimless design for optimum hygiene, ease of cleaning and water saving
- Raised height 480mm from floor to top of seat
- Extended projection
- Seat sold separately

Fixing

- Supplied with floor fixing pack

Material

- Vitreous china to BS 3402

Flushing

- Compatible with OSMO® T1 concealed cistern – CIST200

Seat Options

- Chartham seat only in white – CHWC112
- Chartham seat only in blue – CHWC113
- Chartham seat only in dark grey – CHWC114
- Chartham rimless soft close seat and cover in white – CHWC111

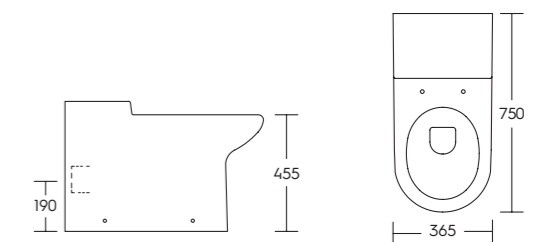

Contour 21+ 750mm Back to Wall Rimless Toilet Pan S0438HY



Armitage Shanks



Armitage Shanks Contour 21+ Rimless Back to Wall Toilet Pan with 480mm raised height and 755mm extended projection for Doc M compliance.

Features & Benefits

- Rimless flush design for increased hygiene and water saving
- Anti-microbial glaze
- Sleek easy to clean design
- Seat sold separately

Fixing

- Supplied with floor fixing pack

Material

- Vitreous china to BS 3402

Flushing

- Compatible with OSMO® T1 concealed cistern – CIST200

Seat Options

Contour 21 seat only with retaining buffers in:

- White – S406601
- Blue – S406636
- Grey – S4066LJ
- Contour 21 seat and cover with top fixing hinges in white – S406501
- Charcoal – S4066RN
- Red – S4066GQ

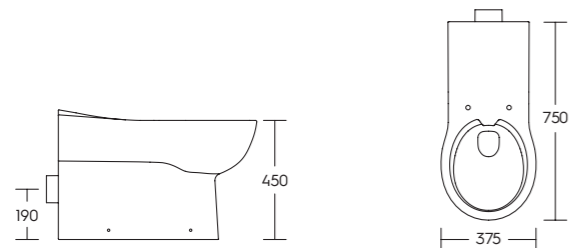

Chartham 480 Back to Wall Rimless Toilet Pan CHWC104



SanCeram



Our SanCeram Chartham Rimless Back to Wall Toilet Pan has a raised height at 480mm from floor to top of seat and is suitable for ambulant areas and is Doc M, HBN and SHTM compliant.

Features & Benefits

- Rimless design for optimum hygiene, ease of cleaning and water saving
- Sleek easy to clean design
- Raised height 480mm from floor to top of seat
- Seat sold separately

Fixing

- Supplied with floor fixing pack

Material

- Vitreous china to BS 3402

Flushing

- Compatible with OSMO® T1 concealed cistern – CIST200

Seat Options

- Chartham rimless soft close seat and cover in white – CHWC111
- Chartham seat only in white – CHWC112
- Chartham seat only in blue – CHWC113
- Chartham seat only in dark grey – CHWC114

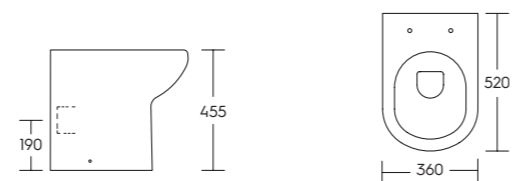

Contour 21+ Raised Height Back to Wall Rimless Toilet Pan S0440HY



Armitage Shanks



Armitage Shanks Contour 21+ Raised Height Back to Wall Rimless Toilet Pan has a height of 480mm and is Doc M, HBN and SHTM compliant.

Features & Benefits

- Rimless design for optimum hygiene and water saving
- Hydrophilic glaze with anti-microbial properties
- Raised height 480mm from floor to top of seat
- Raised outlet for multiple installations
- Seat sold separately

Fixing

- Supplied with floor fixing pack

Material

- Vitreous china to BS 3402

Flushing

- Compatible with OSMO® T1 concealed cistern – CIST200

Seat Options

Contour 21 seat only with retaining buffers in:

- White – S406601
- Blue – S406636
- Grey – S4066LJ
- Contour 21 seat and cover with top fixing hinges in white – S406501
- Charcoal – S4066RN
- Red – S4066GQ

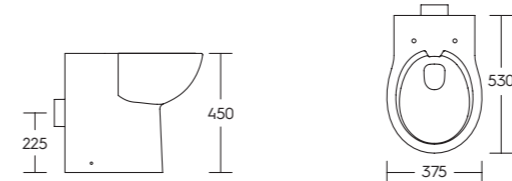

Chartham Back to Wall 700 Rimless Projection Toilet Pan CHWC105



SanCeram



Our SanCeram Chartham Rimless Back to Wall Toilet Pan has extended projection to 700mm for HBN and SHTM compliance.

Features & Benefits

- Rimless design for optimum hygiene, ease of cleaning and water saving
- Raised height 480mm from floor to top of seat
- Extended projection
- Seat sold separately

Fixing

- Supplied with floor fixing pack

Material

- Vitreous china to BS 3402

Flushing

- Compatible with OSMO® T1 concealed cistern – CIST200

Seat Options

- Chartham seat only in white – CHWC112
- Chartham seat only in blue – CHWC113
- Chartham seat only in dark grey – CHWC114
- Chartham rimless soft close seat and cover in white – CHWC111

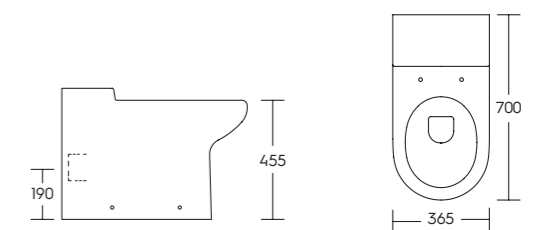

Contour 21+ 700mm Back to Wall Rimless Toilet Pan S0437HY



Armitage Shanks



Armitage Shanks Contour 21+ Rimless 700mm projection Back to Wall Toilet Pan is HBN and SHTM compliant.

Features & Benefits

- Rimless flush design for increased hygiene and water saving
- Anti-microbial glaze
- Sleek easy to clean design
- Raised height 480mm from floor to top of seat
- Extended projection
- Seat sold separately

Fixing

- Supplied with floor fixing pack

Material

- Vitreous china to BS 3402

Flushing

- Compatible with OSMO® T1 concealed cistern – CIST200

Seat Options

Contour 21 seat only with retaining buffers in:

- White – S406601
- Blue – S406636
- Grey – S4066LJ
- Contour 21 seat and cover with top fixing hinges in white – S406501
- Charcoal – S4066RN
- Red – S4066GQ

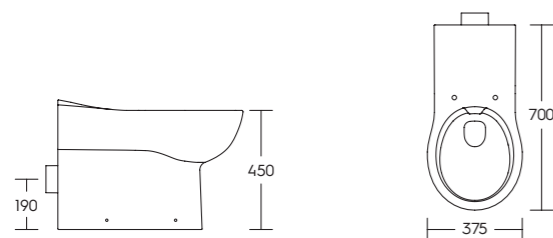

Chartham Wall Hung 700 Projection Toilet Pan CHWC117



SanCeram



Our SanCeram Chartham Wall Hung 700mm Projection Toilet Pan is ideal for Healthcare environments and is HBN and SHTM compliant.

Features & Benefits

- Rimless design for optimum hygiene, ease of cleaning and water saving
- Extended projection
- Seat sold separately

Fixing

- SanCeram support brackets – TSWC117*

Material

- Vitreous china to BS 3402

Flushing

- For HBN or SHTM compliance: Mirage concealed dual flush dimple lever cistern – CIST102
- Also compatible with the OSMO® T1 concealed cistern – CIST200

Seat Options

Chartham seat only:

- White – CHWC112
- Blue – CHWC113
- Dark grey – CHWC114
- Chartham rimless soft close seat and cover in white – CHWC111

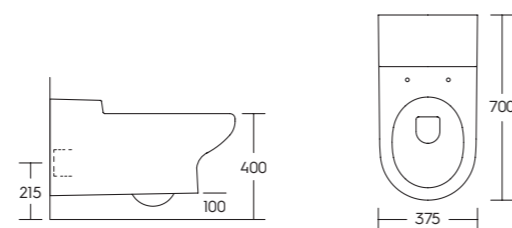

*Not required if installed with WC support frames

Contour 21 Wall Hung 700mm Projection Toilet Pan S307701



Armitage Shanks



Armitage Shanks Contour 21 Wall Hung 700mm Projection Toilet Pan with horizontal outlet and 700mm extended projection offers HBN and SHTM compliance for healthcare installations.

Features & Benefits

- Rimless flush design for increased hygiene and water saving
- Smooth, easy to clean design
- Extended projection
- Seat sold separately

Fixing

- WC Support bracket and bolts for raised height WC – S913967

Material

- Vitreous china to BS 3402

Flushing

Compatible with:

- Conceala 2 4.5/3 or 4/2.6ltr dual flush concealed cistern – S364367
- Sensorflow 21 concealed 4 or 4.5ltr cistern – S359967

Seat Options

Contour 21 seat only with retaining buffers in:

- White – S406601
- Blue – S406636
- Grey – S4066LJ
- Contour 21 seat and cover with top fixing hinges in white – S406501
- Charcoal – S4066RN
- Red – S4066GQ

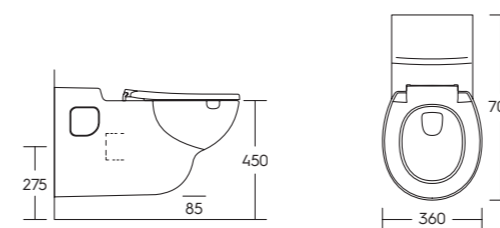

Contour 21+ Wall Hung Rimless Toilet Pan S0443HY



Armitage Shanks



Armitage Shanks Contour 21+ Rimless Wall Hung Toilet Pan includes new, improved rimless technology and a hydrophilic, smooth glaze with anti-microbial properties.

Features & Benefits

- Rimless design for optimum hygiene and ease of cleaning
- Water efficient
- Seat sold separately

Fixing

- WC Support bracket and bolts for raised height WC – S913967

Material

- Vitreous china to BS 3402

Flushing

- Compatible with OSMO® T1 concealed cistern – CIST200

Seat Options

Contour 21 seat only with retaining buffers in:

- White – S406601
- Blue – S406636
- Grey – S4066LJ
- Contour 21 seat and cover with top fixing hinges in white – S406501
- Contour 21 seat and cover, slim slow close in white – S067001
- Charcoal – S4066RN
- Red – S4066GQ

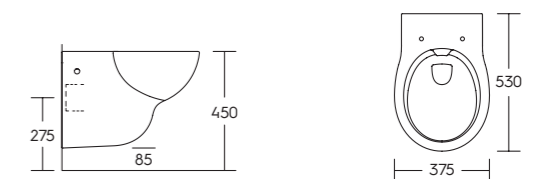

We have a wide range of high quality toilet Cisterns bought to you from renowned market leading brands. Whether you need an Exposed or Concealed Cistern for your project, we can offer a stylish yet practical solution.

With a full and reduced flush, Dual Flush Cisterns are ideal when it comes to saving water and saving money. The flush capacity can be reduced to as little as 4ltr for a full flush and 2.4ltr for a half flush reducing water usage by a third. We also have a selection of Single Flush Cisterns, which when used have the benefit of ensuring the same flush capacity is used each time and not left to user selection.

Toilet Flushes

We also have a wide range of Toilet Flushes that can be used across various sectors including Healthcare and Doc M. We have Push Plates, Push Buttons and Sensor Flushes available in a selection of finishes, so no matter the project we are sure to have a suitable product. You can purchase cisterns and flushing mechanisms separately or you can purchase them together as a bundle for ease.

Sensor Operation Flushing

With hygienic touch free operation, Sensor Flushes are ideal to help stop the spread of germs and bacteria. Many have an adjustable fill delay timer, preventing flushing before the cistern is completely refilled, giving a consistent effective flush. There is also the option of mains powered or battery operation depending on the installation requirements.

Touch Operation Flushing

Our traditional Touch Operation Flushes come in the form of Lever, Button and Push Action. Many offer smooth pneumatic operation, with anti-finger trap design features for safety and ease of use, ideal for schools and public areas. We also have options to accommodate high impact, vandal resistant requirements.

Icon key – Features of our products



**The OSMO™ T1 Concealed Cistern
WRAS approved and reduced installation time...
What's not to like?**

Why choose the OSMO™ T1 Concealed Cistern

- ✓ Multiple flushing volumes for water saving: 6/4 – 5/3 – 4/2.6ltr
- ✓ Compatible with a wide range of single and dual flush push plates, buttons and sensor flushes
- ✓ Factory assembled, unique reversible cistern body due to AXIS Technology® achieving multiple outlet and inlet options without having to swap internals round on site
- ✓ Fluid category 5 cistern; the only way to achieve a water regulations compliant cistern in standard height pod shelves
- ✓ WRAS approved pneumatic flush, cable flush and inlet valve



We recommend...

Education

The anti-finger trap design and pivot action ensuring easy operation, make the Tyde Drift Pneumatic Push Plate ideal for use in education settings.

Commercial

The stylish, Tyde Wave S3 Intelligent Sensor Flush Plate in black glass provides dual flush operation for maximum water saving and hygienic touch free operation.

Best all-rounder

The Tyde OSMO™ T1 Concealed Cistern is a top access, concealed, reversible cistern with AXIS Technology creating multiple inlet options from the same unit – reducing installation time one site.



Tyde Drift Pneumatic Push Plate



Tyde Wave S3 Intelligent Sensor Flush Plate



Tyde OSMO™ T1 Concealed Cistern

Concealed Dual Flush Cistern with Lever CIST101



Tyde Concealed Dual Flush WC Cistern with standard style lever operation, delivers a reduced flush when the lever is held down and full flush when lever is depressed and released.

Features & Benefits

- 6/3ltr dual flush with an effective flush volume of 3.75ltr
- External overflow warning
- Push-fit flush pipe with a one piece hanging bracket
- Top access
- Compact design fits neatly into a duct

Lever Features

- Lever spindle can be cut to length to suit installation depths between 12 to 145mm
- Levers are fitted with vandal-resistant stops to prevent lever being rotated backwards

Material

- High impact polystyrene – Cistern

Standard

- Manufactured under BS EN ISO 9001 and BS EN ISO 14001
- Approved by the European Water Label Scheme

Product Options

- Concealed dual flush cistern with extended lever – CIST102

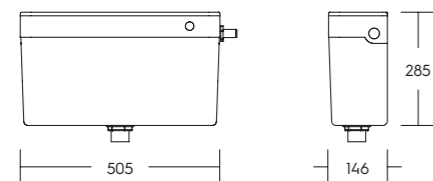

OSMO® T1 Concealed Cistern CIST200



Tyde OSMO® T1 Concealed Cistern with top access, is a concealed reversible fluid category 5 cistern with AXIS Technology creating multiple inlet options from the same unit.

Features & Benefits

- WRAS approved Dudley Niagara pneumatic flush valve
- WRAS approved Dudley Hydroflo AG 7s compact brass tail inlet valve
- Slim 110mm deep cistern body to fit into compact spaces
- Factory assembled
- Multiple flushing volumes: 6/4, 5/3, 4/2.6ltr achieved with removable baffles at installation stage

Material

- High density polystyrene (PS)

Standard

- Manufactured under BS EN ISO 9001 and BS EN ISO 14001
- Supports Code of Sustainable Homes
- Supports BREEAM

Flushing

- Compatible with a range of push buttons, flush plates and infrared controls, see pages 29 - 34

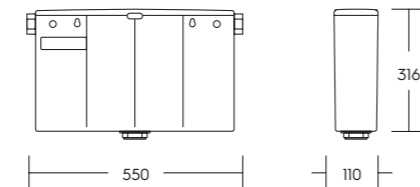

Royal Pneumatic Single Palm Push Button CIST205



Features & Benefits

- Palm push operation for easy use
- Smooth pneumatic operation
- Can be positioned up to 250mm away from the cistern

Required Aperture

- Ø40mm

Material

- ABS

Wall Thickness

- 5 - 46mm

Finish

- Chrome



Royal Metal Pneumatic Single Push Button CIST206



Features & Benefits

- Metal button ideal for use where there is a potential for vandalism or misuse
- Smooth pneumatic operation
- Can be positioned up to 250mm away from the cistern

Required Aperture

- Ø40mm

Material

- Stainless steel

Wall Thickness

- 5 - 46mm

Finish

- Brushed

Dio Pneumatic Dual Push Button CIST211



Features & Benefits

- Dual flush operation for full and water saving reduced flush
- Smooth pneumatic operation
- Can be positioned up to 250mm away from the cistern

Required Aperture

- Ø40mm

Material

- ABS

Wall Thickness

- 12 - 32mm

Finish

- Chrome



Royal Pneumatic Single Push Button
CIST213



- Features & Benefits**
- Single flush
 - Smooth pneumatic operation
 - Can be positioned up to 250mm away from the cistern

Required Aperture

- Ø40mm

Material

- ABS

Wall Thickness

- 5 - 46mm

Finish

- Chrome



Remora Metal Pneumatic Palm Push Button
CIST214



- Features & Benefits**
- Protruding button design for easy use
 - Single flush
 - Anti-vandal
 - Smooth pneumatic operation
 - Can be positioned up to 250mm away from the cistern

Required Aperture

- Ø48mm

Material

- Stainless steel

Wall Thickness

- 5 - 46mm

Finish

- Brushed



Piazza Pneumatic Single Push Button
CIST203

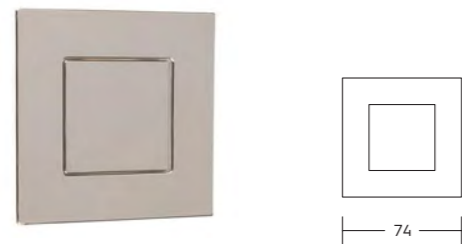

- Features & Benefits**
- Smooth pneumatic operation
 - Chrome plated finish
 - Can be positioned up to 250mm away from the cistern

Required Aperture

- Ø62mm

Material

- ABS

Wall Thickness

- Max 50mm

Finish

- Chrome



Piazza Pneumatic Dual Push Button
CIST204



- Features & Benefits**
- Dual flush operation for full and water saving reduced flush
 - Smooth pneumatic operation
 - Can be positioned up to 250mm away from the cistern

Required Aperture

- Ø62mm

Material

- ABS

Wall Thickness

- Max 50mm

Finish

- Chrome



Oyster Pneumatic Push Plate
CIST207

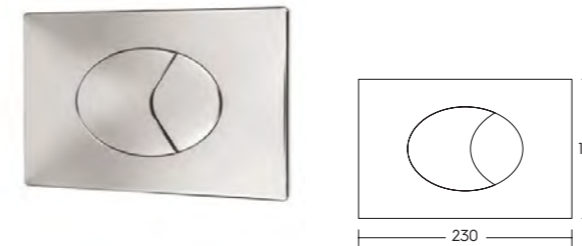

- Features & Benefits**
- Dual flush operation for full and water saving reduced flush
 - Smooth pneumatic operation
 - Can be positioned up to 250mm away from the cistern

Required Aperture

- 205mm x 118mm

Material

- ABS

Rec. Depth Clearance

- Min 80mm

Finish

- Chrome



Reef Pneumatic Push Plate
CIST208

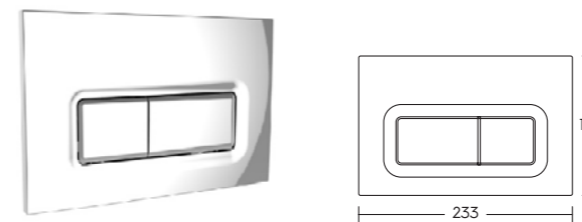

- Features & Benefits**
- Dual flush operation for full and water saving reduced flush
 - Smooth pneumatic operation
 - Can be positioned up to 250mm away from the cistern

Required Aperture

- 205mm x 118mm

Material

- ABS

Rec. Depth Clearance

- Min 110mm

Finish

- Chrome

Product Options

- Reef pneumatic push plate in matt black – CIST208B



Drift Pneumatic Push Plate
CIST219

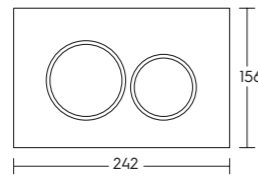

Features & Benefits

- Dual flush operation for full and water saving reduced flush
- Smooth pneumatic operation
- Anti-finger trap design
- Can be positioned up to 250mm away from the cistern

Required Aperture

- 205mm x 118mm

Material

- ABS

Rec. Depth Clearance

- Min 110mm

Finish

- Chrome



Coral Pneumatic Push Plate
CIST209

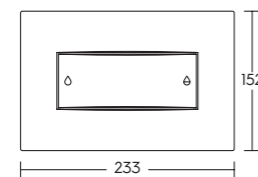

Features & Benefits

- Dual flush operation for full and water saving reduced flush
- Smooth pneumatic operation
- Can be positioned up to 250mm away from the cistern

Required Aperture

- 205mm x 118mm

Material

- ABS

Rec. Depth Clearance

- Min 110mm

Finish

- Chrome

Product Options

- Coral pneumatic push plate in black – CIST209B



Pearl Stainless Steel Push Plate
CIST210

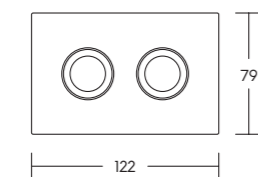

Features & Benefits

- Dual flush operation for full and water saving reduced flush
- High impact vandal-resistant stainless steel construction
- Smooth pneumatic operation
- Can be positioned up to 250mm away from the cistern

Required Aperture

- 2 x Ø40mm at 50mm centres

Material

- Stainless steel

Wall Thickness

- Min 2mm

Finish

- Brushed



Electroflo WC Sensor and Control Box
CIST215



Tyde Electroflo WC Sensor and Control Box Kit, for touch free infrared WC flushing, suitable for use with the OSMO® T1 Concealed Cistern.

Features & Benefits

- Factory set single flush operation can be converted to dual flush easily for maximum water saving
- Hygienic, touch free operation
- LED flush indication
- Post flush sensor delay allows the cistern to refill fully before another flush is delivered
- Dual flush can deliver 6/4, 5/3 or 4/2.6ltr flush volumes
- Battery operated (4 x 1.5V AA batteries)

Operating Voltage

- 6V DC

Nominal Voltage

- 230V AC

Wall Thickness

- Max 45mm

Sensor Range

- Up to 50mm

Surround Options

40mm surround in:

- Chrome – CIST216
- Stainless steel – CIST216SS
- Matt black – CIST216B
- 100mm surround, single flush – CIST217
- 100mm surround, dual flush – CIST218

Compatible Products

- Mains adapter (230V AC 50Hz) – CIST110

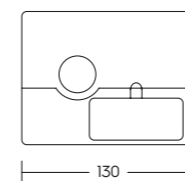

Wave S2 Stainless Steel Sensor Flush Plate
CIST221

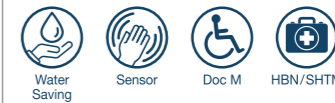

Tyde Wave S2 stainless steel sensor flush plate with Electroflo control and sensor kit, suitable for use with the OSMO® T1 concealed cistern.

Features & Benefits

- Dual flush operation for maximum water saving
- Hygienic touch free operation
- Interactive sensor indicates full or reduced flush activation
- Vandal-resistant design
- Complete with Electroflo sensor and control box
- Can be positioned up to 250mm from the cistern

Operating Voltage

- 6V DC (transformer supplied)

Nominal Voltage

- 230V AC

Fill Delay Time

- 30 secs

Sensor Range

- Up to 50mm

Finish

- Brushed 304 stainless steel

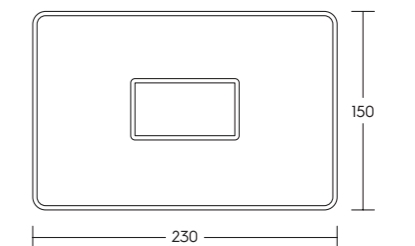

Wave S1 Stainless Steel Sensor Flush Plate CIST222



Tyde Wave S1 stainless steel sensor flush plate with Electroflo control and sensor kit, suitable for use with the OSMO® T1 concealed cistern.

Features & Benefits

- Dual flush operation for maximum water saving
- Hygienic touch free operation
- Interactive sensor indicates full or reduced flush activation
- Vandal-resistant design
- Complete with Electroflo sensor and control box
- Can be positioned up to 250mm from the cistern

Operating Voltage

- 6V DC (transformer supplied)

Nominal Voltage

- 230V AC

Sensor Range

- Up to 50mm

Fill Delay Time

- 30 secs

Finish

- Brushed 304 stainless steel

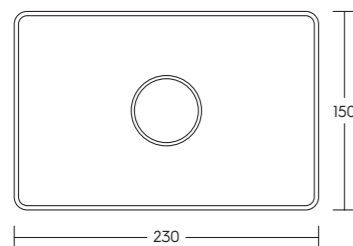

Wave S3 Intelligent Sensor Flush Plate CIST223



Tyde Wave S3 Intelligent Sensor Flush Plate in black glass finish, suitable for use with the OSMO® T1 Concealed Cistern.

Features & Benefits

- Dual flush operation for maximum water saving
- Hygienic touch free operation
- Interactive sensor indicates full or reduced flush activation
- Scratch and graffiti resistant coating reduces risk of damage to front window
- Configured in minutes using simple rear access controls and visual set-up confirmation
- Three sensor range set-up options
- Adjustable fill delay timer prevents flushing before the cistern is completely refilled
- Discrete, tamper resistant, quick release locks for easy service access

Operating Voltage

- 6V DC (transformer supplied)

Nominal Voltage

- 230V AC 50Hz

Sensor Range

- Detection up to 1.8m maximum

Fill Delay Time

- Adjustable 15 - 120 secs

Flush Sensor Range

- 70mm approx. max

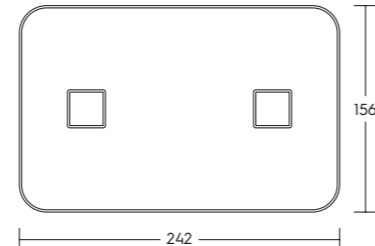

Conceala 2 Cistern – Water Saving Dual Flush S364367



Armitage Shanks Conceala 2 Cistern 4.5/3 or 4/2.6ltr offers a dual flush for water saving and is WRAS approved and HBN and SHTM compliant.

Features & Benefits

- 3ltr average flushing volume
- Top access
- Dual flush valve, side supply, internal overflow
- Factory assembled
- Compact design for install into duct

Material

- Plastic

Flushing

- Contemporary dual flush plate – S4399AA

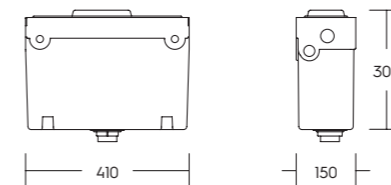

Sensorflow 21 Compact WC Flushing Cistern S359967



Armitage Shanks Sensorflow 21 Compact WC Flushing Cistern has a panel mounted sensor for hygienic touch free operation, with a concealed valve and 4 or 4.5ltr duct cistern.

Features & Benefits

- Top access
- Electronic no touch flushing for increased hygiene
- Water saving
- Complete with concealed valve and panel mounted sensor

Material

- Plastic

Flushing

- Panel mounted sensor

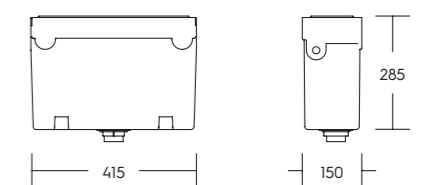

Concealed Plastic Cistern Kit WC02011



KWC DVS



KWC DVS Concealed Plastic Cistern Kit includes side entry valve, flush pipe, back to pan connector, concealed cistern and blanking plug.

Features & Benefits

- 6ltr fill volume
- For wall mounting
- For use with KWC DVS WC flushvalve

Material

- ABS

Flushing

- WC flush valve sensor kit – WC03002

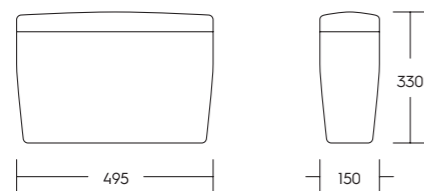

WC in Wall Support Frame with Dual Flush Cistern CIST114



TYDE
fluid movement



Tyde WC in Wall Support Frame with Dual Flush Cistern is suitable for wall hung WC's and is load tested to 400KG and is WRAS approved.

Features & Benefits

- 6/4ltr dual flush can be easily converted to 5/3 or 4/2.6ltr flushing
- Front or top access
- Frame height adjustable from 820 - 1120mm
- Frame legs adjust to offer WC pan height fixing flexibility
- Flushbend and WC pan connector clamps included
- Conceals all pipework for a clean, clutter free finish
- Flush plate sold separately

Standard

- The cistern conforms to BS EN 14055:2010

Flush Plate

- Compatible with a wide range of dual flush plates and buttons, see pages 29 - 34.

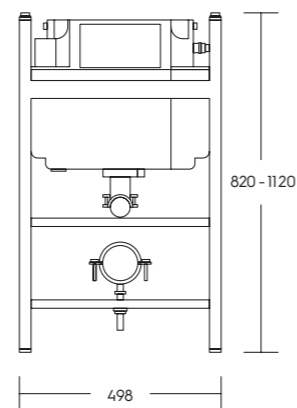

Your dedicated online resource

Our website is designed to make your life easier and offers a hub of useful information. You can visit us at www.theswc.co.uk or use the quick links below.

Technical Library

Download and save technical documents to your personal project folders



Delivery information

Learn more about our speedy delivery service and how your order will be sent out



Environmental Policy

We are committed to minimising potentially harmful effects of our activities, products and services on the environment



Terms and Conditions of Sale

View our full Terms and Conditions online

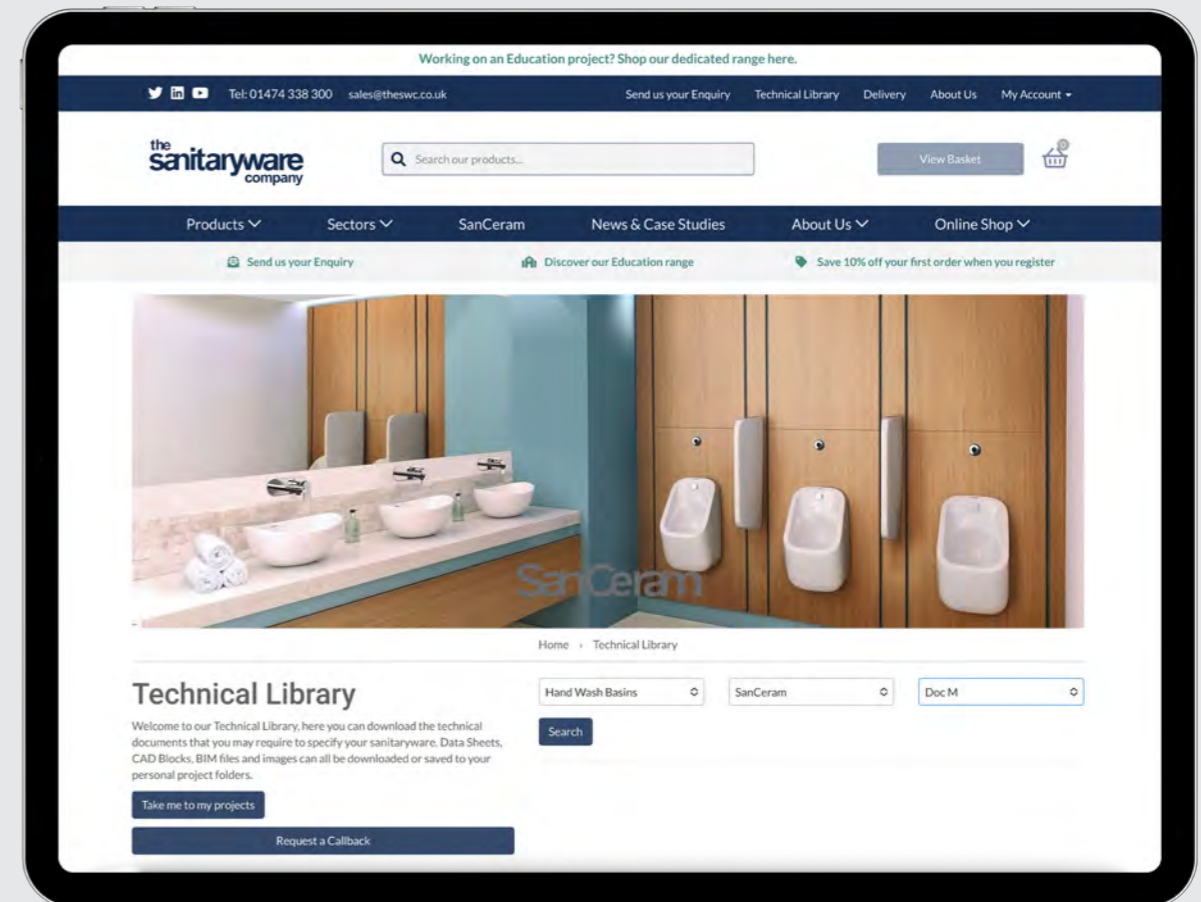

We have a collection of Concealed and Exposed Trap Urinals suitable for all applications including healthcare, commercial and anti-vandal options. With distinctive, modern and easy to clean styles, our comprehensive range features concave back fascia's specifically designed to reduce splash back and waterless options for those who wish to reduce water consumption.

To complement our range of Urinals there is also a number of flushing options available for each product, including room and individual sensor solutions, plus Exposed and Concealed Cisterns. We also have a selection of fittings available including, Urinal Separators, Spreaders and Wastes.

Waterless Urinals

Our Waterless Urinals offer a modern, sleek design that are ideal for those looking to save water and money. Our specialist cartridges designed to trap odours are available to purchase in packs of up to 32, making them very cost effective.

Concealed and Exposed Cisterns

Our range of Concealed and Exposed Cisterns are available with 4.5lt and 9lt capacities, all with automatic syphons. Our Concealed Cisterns are ideal for the more design conscious washrooms and for installations where you do not want the cistern exposed to possible tampering.

Urinal Sensor Flushes

Individual Urinal Sensor Flushes offer hygienic, touch free operation. A sensor sits neatly above the urinal bowl and flushes that single bowl when the user has moved away. This offers huge water saving benefits compared to traditional urinal flushing systems.

- Delivering as little as 1 litre of water per flush, the Electroflo Individual Urinal Sensor Kit provides significant water and financial savings compared with traditional petcocks
- Automatically flushes each urinal after use, along with a built in maintenance flush ensuring the highest level of hygiene from the minimum volume of water
- No wasted water when the area is not in use
- Where multi station urinal flushing is required, the Kinetic Urinal Room Sensor Control can be used which regulates flushing based on actual washroom usage to save up to 80% of water when compared to traditional systems



Icon key – Features of our products



Individual Urinal Sensor Flushes offer maximum water saving benefits, flushing only the urinal that has been used using as little as 1ltr per flush.



We recommend...

Commercial

The Armitage Shanks Contour Urinal Bowl has been specially designed for ducted services. All the service connections are completely concealed, ensuring HBN/SHTM compliancy for healthcare installations.

Hotel

The SanCeram Chartham Exposed Trap Urinal Bowl has a sleek, easy to clean design and can be installed with either a back inlet spreader for concealed cistern feed or top inlet spreader for exposed cistern feed.

Best all-rounder

The SanCeram Marden Concealed Trap Urinal Bowl offers a stylish modern look and is ideal for use in education, leisure and commercial settings.



Installed at: European Space Agency ECSAT Conference Facility



Installed at: Consall Hall Gardens



Installed at: Huddersfield University

Chartham Exposed Trap Urinal Bowl
CHUR104



SanCeram

Our SanCeram Chartham Exposed Trap Urinal Bowl can be installed with either a back inlet spreader for concealed cistern feed or top inlet spreader for exposed cistern feed.

Features & Benefits

- Sleek easy to clean design
- Exposed bottle trap design
- Can be mounted at lower height
- Compatible with concealed or exposed cisterns

Fixing

- Hanging brackets for Chartham urinal bowl – CHUR106

Material

- Vitreous china to BS 3402

Compatible products

- Chartham top inlet spreader (for exposed cistern) – CHUR105
- Back inlet spreader (for concealed cistern) – MDUR102
- 1½" domed urinal waste – URIN116
- 1½" resealing bottle trap – C10R

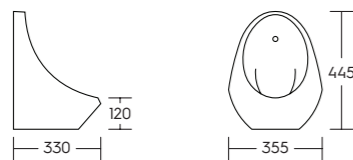

Sanura 500mm Urinal Bowl
S610001



Armitage Shanks

Armitage Shanks Sanura 500mm Urinal Bowl can be mounted at a lower height and is suitable for combined adult and junior installations.

Features & Benefits

- Sleek easy to clean design
- Exposed bottle trap design
- Can be mounted at lower height
- Compatible with concealed or exposed cisterns

Fixing

- Concealed urinal hangers – S927567

Material

- Vitreous china to BS 3402

Compatible products

- Urinal top inlet urinal spreader (for exposed cistern) – S6285AA
- 1½" plastic bottle trap – S892567
- 1½" domed plastic strainer waste, unslotted – S885067
- 1½" strainer waste brass with stainless steel dome – S8770MY
- Urinal back inlet spreader (for concealed cistern) – S6286AA

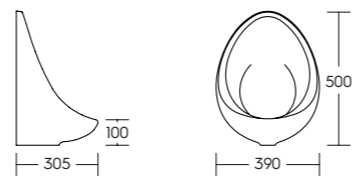

Marden Concealed Trap Urinal Bowl
MDUR101



SanCeram



Our SanCeram Marden Concealed Trap Urinal Bowl with Fixings is for use with a back inlet spreader and concealed cistern feed and is HBN and SHTM compliant.

Features & Benefits

- Sleek easy to clean design
- Concealed bottle trap design
- Ideal for anti-vandal installation
- Compatible with concealed cisterns only

Fixing

- Supplied with concealed hangers (pair)

Material

- Vitreous china to BS 3402

Compatible products

- Square back inlet spreader – MDUR102
- 1½" domed urinal waste – URIN116
- 1½" P trap – L10
- 1½" elbow – URIN117

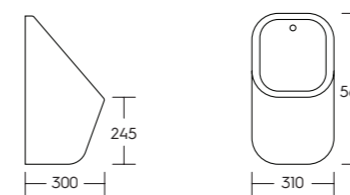

Langley Concealed Trap Urinal Bowl
LLUR101



SanCeram



Our SanCeram Langley Concealed Trap Urinal Bowl offers a sleek, easy to clean design that will fit in to any washroom area and is HBN and SHTM compliant.

Features & Benefits

- Concealed bottle trap design
- Ideal for anti-vandal installation
- Compatible with concealed cisterns only

Fixing

- Langley urinal fixings – LLUR103

Material

- Vitreous china to BS 3402

Compatible products

- Round back inlet spreader – LLUR102
- Square back inlet spreader – MDUR102
- 1½" domed urinal waste – URIN116
- 1½" P trap – L10
- 1½" elbow – URIN117

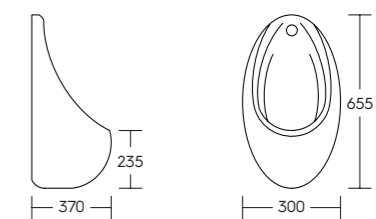

Contour Urinal Bowl
S611001



Armitage
Shanks



HBN/SHTM

Armitage Shanks Contour Urinal Bowl has a concealed trap for a clean, modern finish and is HBN and SHTM compliant.

Features & Benefits

- Sleek easy to clean design
- Concealed bottle trap design
- Ideal for anti-vandal installations
- Compatible with concealed or exposed cisterns

Fixing

- Concealed urinal hangers – S927567

Material

- Vitreous china to BS 3402

Compatible products

- Urinal back inlet spreader – S6286AA
- 1½" plastic P trap – S897067
- 1½" plastic domed strainer waste, unslotted tail – S885067
- 1½" strainer waste brass with stainless steel dome – S8770MY
- Toggle bolts to suit max 25mm panel thickness – S927667

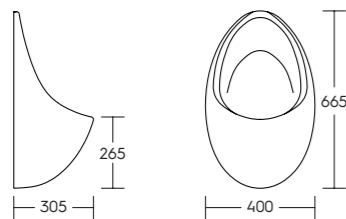

Marden Waterless Urinal
MDUR103



SanCeram



Water Saving

Our SanCeram Marden Waterless Urinal comes with spreader hole cover and one waterless urinal cartridge, perfect for those wanting to save water.

Features & Benefits

- Sleek easy to clean design
- Concealed bottle trap design
- Water saving
- Includes 1 waterless cartridge

Fixing

- Supplied with concealed hangers (pair)

Material

- Vitreous china to BS 3402

Replacement Waterless Cartridge Packs

- Single waterless cartridge – URIN118
- Waterless cartridge pack of 4 – URIN119
- Waterless cartridge pack of 12 – URIN120

Compatible products

- 1½" P trap – L10
- 1½" elbow – URIN117

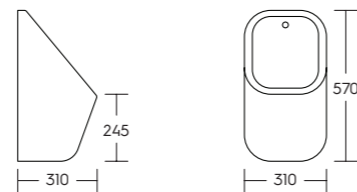

Langley Waterless Urinal
LLUR104



SanCeram



Water Saving

Our SanCeram Langley Waterless Urinal will fit into any modern or traditional washroom and is ideal for those wanting to save water.

Features & Benefits

- Sleek easy to clean design
- Concealed bottle trap design
- Water saving
- Includes 1 waterless cartridge

Fixing

- Langley urinal fixings – LLUR103

Material

- Vitreous china to BS 3402

Replacement Waterless Cartridge Packs

- Single waterless cartridge – URIN118
- Waterless cartridge pack of 4 – URIN119
- Waterless cartridge pack of 12 – URIN120

Compatible products

- 1½" P trap – L10
- 1½" elbow – URIN117

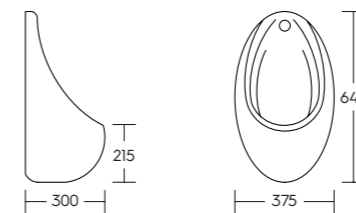

Urinal Separator
CHUR107



SanCeram

Our SanCeram Urinal Separator with secure concealed hanger has an ultra slim design.

Features & Benefits

- Minimalistic design
- Complete with fixings

Fixing

- Supplied with concealed hanger and fixings

Material

- Vitreous china to BS 3402

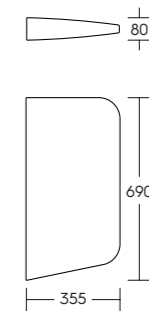

Electroflo Individual Urinal Sensor Kit - Battery Powered URIN108



Tyde Electroflo Individual Urinal Sensor Kit provides touch-free, hygienic operation without the need for mains power.

Features & Benefits

- Flushing is activated when the user has moved away
- Sensor sits above the urinal bowl
- Can be installed into partitioning material and tiles
- Water saving – delivers as little as 1ltr of water per flush
- Adjustable flushing time 1 - 20 seconds with optional remote
- Sensor has a range of 300mm - 550mm
- 24 hour hygiene flush
- Complete with solenoid valve

Fixing

- Supplied with securing nut
- Sensor supplied with 15mm push-fit connection 1/2" BSP connectors for sensor pack

Material

- Chrome plated sensor surround

Essential items

- 15mm air break – URIN110 surround

Technical Specification

- Working pressure 0.3 - 8.0 bar

Product Options

- Electroflo individual urinal sensor kit mains powered – URIN109

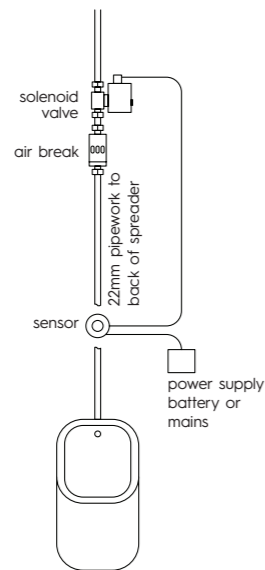

Kinetic Urinal Room Sensor Control URIN123



Tyde Kinetic Urinal Room Sensor Control offers flexible installation allowing the unit to be installed mounted into a wall, ceiling or as part as exposed pipework.

Features & Benefits

- Infra-red sensor ideal for use with automatic cisterns and multiple station urinals
- Sensor detects user movement (up to 5m) in the washroom and fills the cistern to flush after a pre-set time based on the traffic in the area
- Hygiene and economy mode options
- Control box can be installed up to 1m away from the solenoid valve
- Fitted with a 6ltr/min flow restrictor
- Battery or mains powered
- Comes complete with solenoid valve and compression adapter

Operating Pressure

- 0.1 - 10 bar

Product Options

- Kinetic urinal sensor flush control
- Grey – URIN124

Fixing

- Includes flush mounting kit

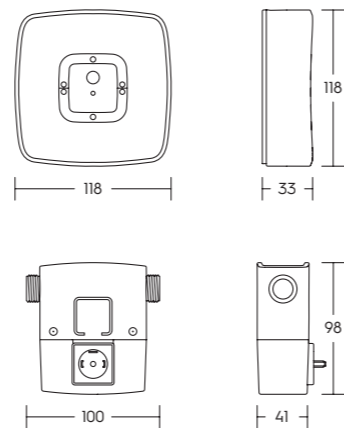

Concealed 4.5ltr Urinal Cistern with Automatic Syphon URIN101



Tyde Concealed 4.5ltr Urinal Cistern with Automatic Syphon and petcock, suitable to feed 1- 2 urinal bowls.

Features & Benefits

- Supplied with petcock and auto syphon
- Outlet centre 73mm from wall
- 4.5ltrs to supply 1 or 2 urinal bowls
- Constructed from high impact polystyrene
- Use in combination with kinetic urinal room sensor for full regulatory compliance

Fixing

- One piece hanging bracket supplied

Material

- High impact polystyrene

Product Options

- 9ltr urinal cistern for 3 urinal bowls – URIN102
- 13.5ltr urinal cistern for 4 urinal bowls – URIN103

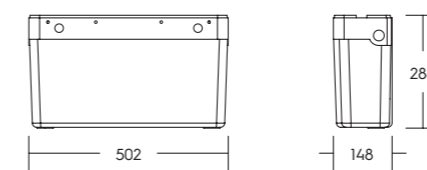

Exposed Dudley 'D' 4.5ltr Urinal Cistern with Automatic Syphon URIN104



Tyde Exposed Dudley 'D' 4.5ltr Urinal Cistern with Automatic Syphon, suitable to feed 1- 2 urinal bowls.

Features & Benefits

- Supplied with petcock and auto syphon
- Outlet centre 93mm from wall
- 4.5ltrs to supply 1 or 2 urinal bowls
- Constructed from high impact polystyrene
- High gloss white finish
- Use in combination with kinetic urinal room sensor for full regulatory compliance

Fixing

- One piece hanging bracket supplied

Material

- High impact polystyrene

Product Options

- 9ltr exposed urinal cistern for 3 urinal bowls – URIN105

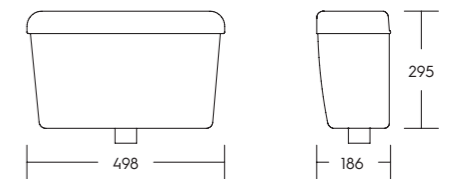

Exposed Tri-shell 4.5ltr Urinal Cistern with Automatic Syphon URIN106



Tyde Exposed Tri-shell 4.5ltr Urinal Cistern with Automatic Syphon, suitable to feed 1 or 2 urinal bowls.

Features & Benefits

- Supplied with petcock and auto syphon
- Outlet centre 90mm from wall
- 4.5ltr to supply 1 or 2 urinal bowls
- Sandwich foam moulded construction for strength and durability
- Construction reduces surface condensation
- Lightweight material for easy mounting
- High-gloss finish
- Use in combination with kinetic urinal room sensor for full regulatory compliance – URIN123

Fixing

- One piece hanging bracket supplied

Material

- Unique sandwich foam moulded resin core

Product Options

- 9ltr Tri-shell exposed urinal cistern for 3 urinal bowls – URIN107

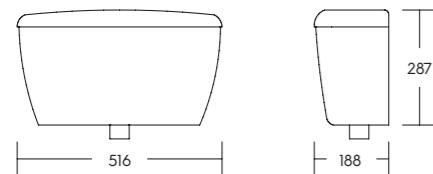

Single Station Exposed Urinal Flush Pipe URIN113



SanCeram

SanCeram Single Station Exposed Urinal Flush Pipe, complete with pipe supports and wall fixings.

Features & Benefits

- All pipes pre-shaped and cut to meet cistern and spreader
- For exposed urinal cistern installation only
- Durable stainless steel construction

Size (mm)

- 1045mm length

Material

- Stainless steel

Product Options

- Two station exposed urinal flush pipes – URIN114
- Three station exposed urinal flush pipes – URIN115

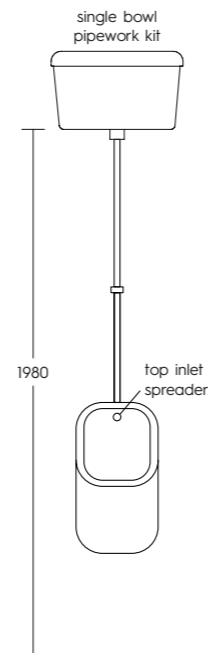

Online Trade Account

Whether you're a one man band, or a large national company, our aim is to provide the very best online ordering experience. Our Online Trade Account is the ideal way to make your life as easy as possible when it comes to ordering your Sanitaryware products.

Setting up your Online Trade Account is quick and easy and some of the benefits include:

Speed:

- Many items available for next day delivery
- Paperless orders, with a quick order process, saving you time and money
- Orders can be placed 24/7 anytime, anywhere

Flexibility:

- Multiple users can be added to your account, allowing site teams to order items direct
- Manage your account online, view and pay invoices, giving you control of your finances
- When on our mailing list you will be informed about any discounts and special offers

Cost:

- Spend up to your credit limit and pay up to 30 days later (T&C's apply)
- Get offers and the best package deals with our bundle options
- Free standard delivery for orders over £500 (UK Mainland)
- Find competitive prices on market leading brands



It's quick and easy... simply click the button to set up your Online Trade Account

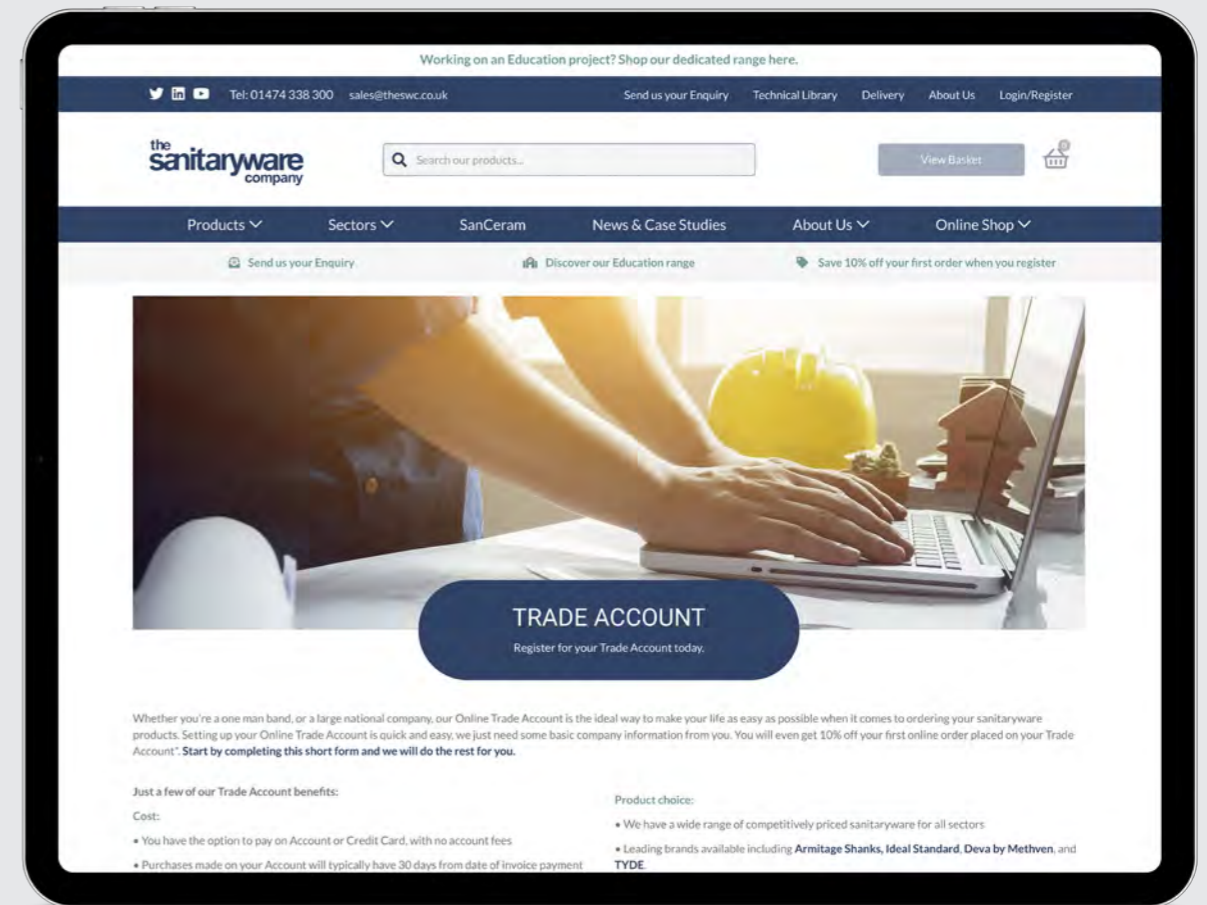

Our extensive range of Hand Wash Basins cover everything from practical designs for education projects right through to luxurious elegance for commercial and high end residential installations. We also have a select range of Hand Wash Basins that are HBN/SHTM compliant, suitable for healthcare projects.

Wall Hung Basins

Our varied range of Wall Hung Basins are ideal for where space is restricted. Whether you're looking for a stylish basin in a commercial washroom, HBN compliant sanitaryware for a healthcare setting or a row of small Wall Hung Wash Basins for a school washroom refurbishment, we have the perfect solution.

Semi-recessed Basins

With clean, smooth lines, all of our Semi-recessed Basin designs are perfect for today's modern washrooms. We have a variety of designs including square Semi-recessed Basins for a stunning minimalist look and ergonomic small Semi-recessed Basins for washrooms with space limitations.

Countertop Basins

Our dedicated Hand Wash Basin product range includes modern Countertop Inset Basins. There are many shapes and sizes available, including rectangular, oval and round designs, with a choice of single or two tap holes.

Under Counter Basins

Suitable for both domestic and commercial applications, our Under Counter Basins are right-on-trend and can even be installed as an inset basin into the vanity top for greater installation flexibility.

Vessel Basins

Our range of modern Vessel Basins are brought to you exclusively by SanCeram, bringing a unique look to any washroom to suit a variety of budgets. We have also have a range of tall vessel taps to complement our Vessel Basins, ideal for a contemporary bathroom or high end commercial washroom.

Solid Surface Wash Troughs

Solid Surface Wash Troughs are becoming an increasingly popular alternative to traditional Hand Wash Basins, due to their low maintenance and aesthetically pleasing nature. The hygienic smooth surface stops germs harbouring and makes them easy to clean, perfect for public spaces with a high footfall.

Icon key – Features of our products



HBN/SHTM



Doc M



Click the button to view our full range of Hand Wash Basins online

Our modern and durable Solid Surface Wash Troughs are the perfect addition to any commercial or education washroom. Being both stylish and timeless, they are extremely hard-wearing and will stand the test of time even in the most demanding environment.

Why choose Solid Surface Wash Troughs

- ✔ Manufactured from an advanced composition of minerals and acrylic polymer, they are renowned for their exceptional durability
- ✔ Choice of profiles suitable for wall mounted or deck mounted taps with stainless steel cantilever brackets – compatible with our wide range of SanCeram Brassware
- ✔ Offering a larger hand washing area than basins, they help confine water to avoid excess splashing – ideal for schools and public washrooms
- ✔ Designed for multiple users, they encourage the flow of users through the washroom area
- ✔ Easily repairable – scratches can be sanded out and wiped clean



We recommend...

Healthcare

Our SanCeram Chartham Wall Hung 500 Clinical Back Outlet Basin is both HBN and SHTM compliant, so you can install it in your clinical environment with confidence.

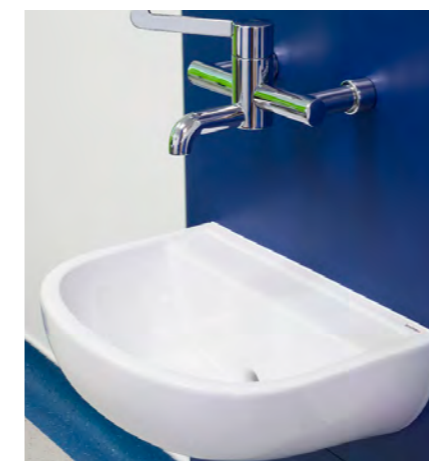

Installed at: Acre Mills Hospital

Hotel

Our SanCeram Langley Rectangular Vessel Basin oozes style and luxury with its contemporary slim sided appearance.



Installed at: Consall Hall Gardens

Best all-rounder

Our SanCeram Chartham Semi-recessed Basin has clean, smooth lines and is a perfect, economic addition to any modern bathroom.



Installed at: Merthyr Tydfil Bus Station

Chartham Wall Hung 380 Basin LHTH
CHWB101

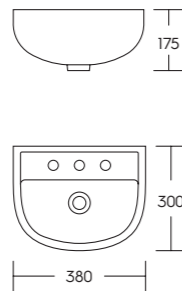

Features & Benefits

- No overflow or chain hole
- Left hand tap hole
- Bottom outlet for ease of maintenance
- Ideal for use in small spaces

Fixing

- Includes fisher fixings

Material

- Vitreous china to BS 3402

Compatible Products

- 1¼" unslotted wastes – see page 78
- 1¼" bottle traps – see page 80

Product Options

- Chartham 380 basin RHTH – CHWB102



SanCeram

Contour 21 370mm Wall Hung Basin
LHTH S247301

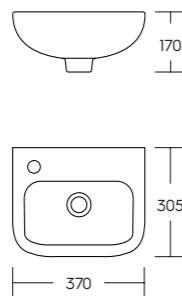

Features & Benefits

- No overflow or chain hole
- Left hand tap hole
- Bottom outlet for ease of maintenance
- Ideal for use in small places

Fixing

- Concealed hangers – S911067

Material

- Vitreous china to BS 3402

Compatible Products

- 1¼" unslotted wastes – see page 78
- 1¼" bottle traps – see page 80

Product Options

- Contour 21 370 wall hung basin RHTH – S247401



Armitage Shanks

Chartham Wall Hung 500 Basin RHTH
CHWB105

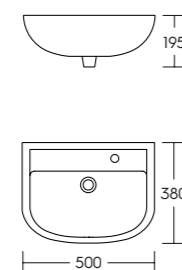

Features & Benefits

- No overflow or chain hole
- Right hand tap hole
- Bottom outlet for ease of maintenance

Fixing

- Includes fisher fixings

Material

- Vitreous china to BS 3402

Compatible Products

- 1¼" unslotted wastes – see page 78
- 1¼" bottle traps – see page 80



SanCeram

Portman 21 Wall Hung 500mm Basin
RHTH S225401

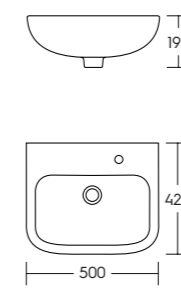

Features & Benefits

- No overflow or chain hole
- Right hand tap hole
- Bottom outlet for ease of maintenance

Fixing

- Wall fixing set – E015767
- IPS fixing set – E006267

Material

- Vitreous china to BS 3402

Compatible Products

- 1¼" unslotted wastes – see page 78
- 1¼" bottle traps – see page 80

Product Options

- Portman 21 wall hung 500 2TH no overflow – S225301



Armitage Shanks

Chartham Wall Hung 500 Clinical Back Outlet Basin
CHWB107

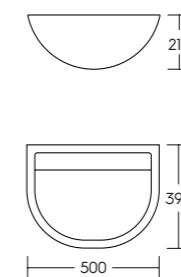

Features & Benefits

- No overflow or chain hole
- No tap hole
- Back outlet for increased infection control
- Includes fisher fixings for installation

Fixing

- Mounting and waste adaptor – TSWC110

Material

- Vitreous china to BS 3402

Required Items

- 1¼" plastic resealing bottle trap – A10R



SanCeram

Contour 21+ 500mm Back Outlet Washbasin
S0430HY

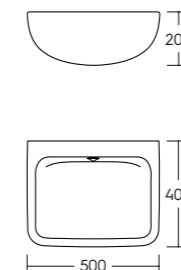

Features & Benefits

- No overflow or chain hole
- No tap hole
- Back outlet for increased infection control
- Anti-microbial glaze
- Anti-splash 'fin' feature

Fixing

- Washbasin fixing set – S038867

Material

- Vitreous china to BS 3402

Compatible Products

- Contour 21+ waste adaptor kit – S038667



Armitage Shanks

Contour 21+ 600mm Back Outlet Washbasin S0444HY

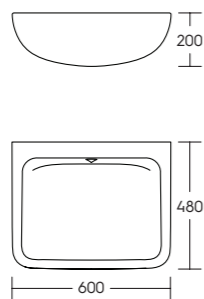

Features & Benefits

- No overflow or chain hole
- No tap hole
- Back outlet for increased infection control
- Anti-microbial glaze
- Anti-splash 'fin' feature

Fixing

- Washbasin fixing set – S038867

Material

- Vitreous china to BS 3402

Compatible Products

- Contour 21+ waste adaptor kit – S038667

Armitage
Shanks



Chartham Wall Hung 450 Basin CTH CHWB104

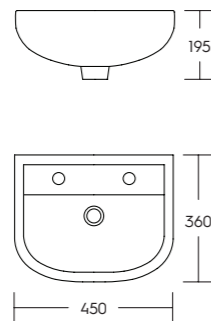

Features & Benefits

- Overflow
- No chain hole
- Central tap hole
- Bottom outlet for ease of maintenance

Fixing

- Includes fisher fixings

Material

- Vitreous china to BS 3402

Compatible Products

- 1 1/4" slotted wastes – see page 78
- 1 1/4" bottle traps – see page 80

Product Options

- Chartham wall hung 450 basin 2TH – CHWB103

SanCeram

Marden Wall Mounted 420 Basin CTH MDWB101

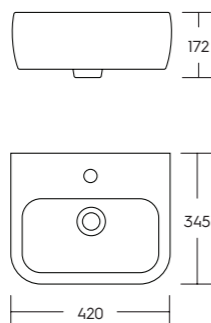

Features & Benefits

- Overflow
- Central tap hole
- Bottom outlet for ease of maintenance
- Ergonomic modern styling

Fixing

- Includes fisher fixings

Material

- Vitreous china to BS 3402

Compatible Products

- 1 1/4" slotted wastes – see page 78
- 1 1/4" bottle traps – see page 80

SanCeram

Marden Wall Mounted 525 Basin CTH MDWB103

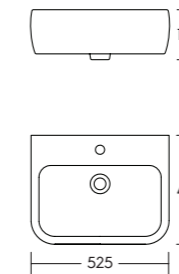

Features & Benefits

- Overflow
- Central tap hole
- Bottom outlet for ease of maintenance
- Ergonomic modern styling

Fixing

- Includes fisher fixings

Material

- Vitreous china to BS 3402

Compatible Products

- 1 1/4" slotted wastes – see page 78
- 1 1/4" bottle traps – see page 80

SanCeram

Concept Sphere 450mm Wall Hung CTH Basin E805501



Features & Benefits

- Overflow
- Central Ttap hole
- Bottom outlet for ease of maintenance
- Smooth modern design

Fixing

- Wall fixing set – E015767

Material

- Vitreous china to BS 3402

Compatible Products

- 1 1/4" slotted wastes – see page 78
- 1 1/4" bottle traps – see page 80

Ideal Standard

Shenley Slim Wall Hung 450 Basin RHTH SHWB101

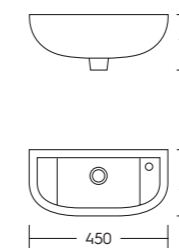

Features & Benefits

- Overflow
- Right hand tap hole
- Bottom outlet for ease of maintenance
- Ideal for use in small spaces

Fixing

- Includes fisher fixings

Material

- Vitreous china to BS 3402

Compatible Products

- 1 1/4" slotted wastes – see page 78
- 1 1/4" bottle traps – see page 80

SanCeram

Shenley Slim Semi-recessed Basin 400
RHTH SHWB105

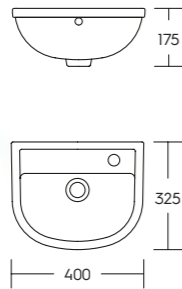

Features & Benefits

- Overflow
- Right hand tap hole
- Bottom outlet for easy maintenance
- Ideal for use in small spaces

Material

- Vitreous china to BS 3402

Compatible Products

- 1 1/4" slotted wastes – see page 78
- 1 1/4" bottle traps – see page 80

Product Options

- Two tap hole Shenley slim semi-recessed basin – SHWB106

SanCeram

Chartham Semi-recessed Basin 450
RHTH CHWB109

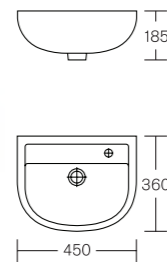

Features & Benefits

- Overflow
- No chain hole
- Right hand tap hole
- Bottom outlet for ease of maintenance

Material

- Vitreous china to BS 3402

Compatible Products

- 1 1/4" slotted wastes – see page 78
- 1 1/4" bottle traps – see page 80

Product Options

- Two tap hole Chartham semi-recessed basin – CHWB108

SanCeram

Sandringham 21 500mm Semi-recessed Basin CTH E895801

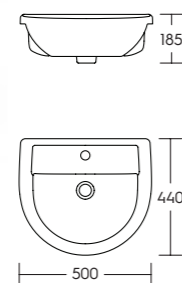

Features & Benefits

- Overflow
- No chain hole
- Central tap hole
- Bottom outlet for ease of maintenance

Material

- Vitreous china to BS 3402

Compatible Products

- 1 1/4" slotted wastes – see page 78
- 1 1/4" bottle traps – see page 80

Product Options

- Two tap hole Sandringham 21 500 semi-recessed basin – E896101

Armitage
Shanks

Marden Semi-recessed 520 Basin CTH
MDWB105

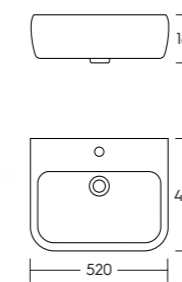

Features & Benefits

- Overflow
- No chain hole
- Central tap hole
- Bottom outlet for ease of maintenance

Material

- Vitreous china to BS 3402

Compatible Products

- 1 1/4" slotted wastes – see page 78
- 1 1/4" bottle traps – see page 80

SanCeram

Profile 21 500mm Semi-recessed Basin CTH S249201

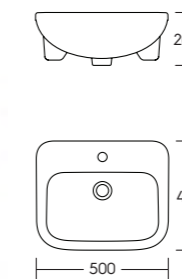

Features & Benefits

- Overflow
- No chain hole
- Central tap hole
- Bottom outlet for ease of maintenance

Material

- Vitreous china to BS 3402

Compatible Products

- 1 1/4" slotted wastes – see page 78
- 1 1/4" bottle traps – see page 80

Armitage
Shanks

Marden Square Semi-recessed 460 Basin CTH MDWB113

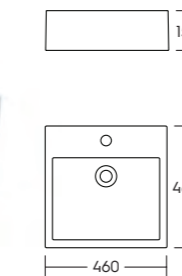

Features & Benefits

- Overflow
- No chain hole
- Central tap hole
- Bottom outlet for ease of maintenance

Material

- Vitreous china to BS 3402

Compatible Products

- 1 1/4" slotted wastes – see page 78
- 1 1/4" bottle traps – see page 80

SanCeram

**Concept Space Cube 500mm
Semi-recessed Basin RHTH E779901**

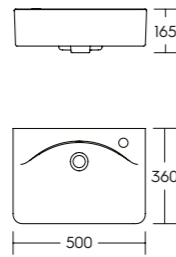

Features & Benefits

- Overflow
- No chain hole
- Right hand tap hole
- Bottom outlet for ease of maintenance
- Space saving design
- Install into a semi-recessed vanity or worktop

Material

- Vitreous china to BS 3402

Compatible Products

- 1¼" slotted wastes – see page 78
- 1¼" bottle traps – see page 80



Ideal Standard

**Chartham Countertop 530 Basin CTH
CHWB112**

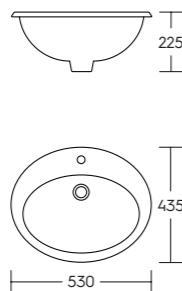

Features & Benefits

- Overflow
- No chain hole
- Central tap hole
- Bottom outlet for ease of maintenance
- Minimalistic design

Material

- Vitreous china to BS 3402

Compatible Products

- 1¼" slotted wastes – see page 78
- 1¼" bottle traps – see page 80

SanCeram

**Sandringham 21 500mm Countertop
Basin CTH E895201**

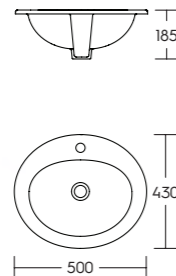

Features & Benefits

- Overflow
- No chain hole
- Central tap hole
- Bottom outlet for ease of maintenance

Material

- Vitreous china to BS 3402

Compatible Products

- 1¼" slotted wastes – see page 78
- 1¼" bottle traps – see page 80

Product Options

- Two tap hole Sandringham 21 500 countertop basin – E895301

Armitage
Shanks

**Shenley Central Tap Hole
Countertop 500 Basin SHWB103**

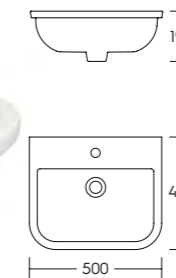

Features & Benefits

- Overflow
- No chain hole
- Central tap hole
- Bottom outlet for easy maintenance

Material

- Vitreous china to BS 3402

Compatible Products

- 1¼" slotted wastes – see page 78
- 1¼" bottle traps – see page 80

Product Options

- Two tap hole Shenley countertop basin – SHWB104

SanCeram

**Orbit 21 550mm Countertop Basin CTH
S251301**

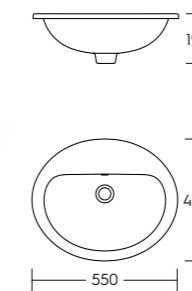

Features & Benefits

- Overflow
- No chain hole
- Central tap hole
- Bottom outlet for ease of maintenance

Material

- Vitreous china to BS 3402

Compatible Products

- 1¼" slotted wastes – see page 78
- 1¼" bottle traps – see page 80

Product Options

- Two tap hole Orbit countertop basin – S248801



Ideal Standard

**Marden Inset / Under Counter 560 Basin
MDWB107**

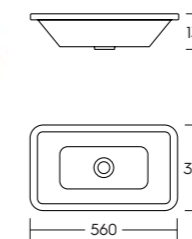

Features & Benefits

- No tap hole
- Bottom outlet for ease of maintenance
- Glazed rim to allow inset or under mounting
- Ergonomic modern styling

Material

- Vitreous china to BS 3402

Essential Items

- Overflow adapter and waste – TSWC111

Compatible Products

- 1¼" slotted wastes – see page 78
- 1¼" bottle traps – see page 80

SanCeram

Langley Inset / Under Counter 400 Basin LLWB107

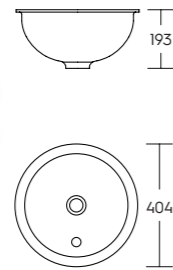

Features & Benefits

- No tap hole
- Bottom outlet for ease of maintenance
- Glazed rim to allow inset or under mounting
- Minimalistic design

Material

- Vitreous china to BS 3402

Essential Items

- Overflow adaptor and waste – TSWC111

Compatible Products

- 1¼" slotted wastes – see page 78
- 1¼" bottle traps – see page 80

SanCeram

Marden Square Basin 460 CTH MDWB111

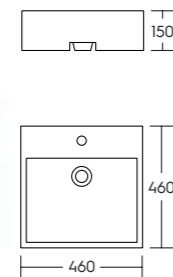

Features & Benefits

- Overflow
- Central tap hole
- Bottom outlet for ease of maintenance
- Install onto a vanity or mount as wall hung
- Stylish, minimalistic design

Fixing

Includes fisher fixings

Material

- Vitreous china to BS 3402

Compatible Products

- 1¼" slotted wastes – see page 78
- 1¼" bottle traps – see page 80

SanCeram

Chartham Beyond Vessel Basin CHWB120

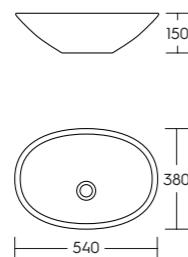

Features & Benefits

- No tap holes or overflow
- Bottom outlet for ease of maintenance
- Install onto a vanity or worktop
- Minimalistic design

Material

- Vitreous china to BS 3402

Compatible Products

- 1¼" unslotted wastes – see page 78
- 1¼" bottle traps – see page 80

SanCeram

Langley Vessel Basin LLWB108

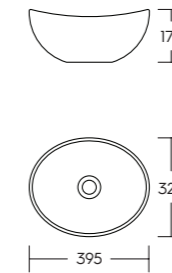

Features & Benefits

- No tap holes or overflow
- Bottom outlet for ease of maintenance
- Install onto a vanity or worktop

Material

- Vitreous china to BS 3402

Compatible Products

- 1¼" unslotted wastes – see page 78
- 1¼" bottle traps – see page 80

SanCeram

Langley Round Vessel Basin LLBW122

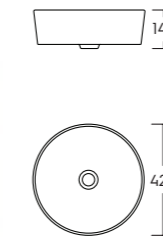

Features & Benefits

- No tap holes or overflow
- Bottom outlet for ease of maintenance
- Install onto a vanity or worktop

Material

- Vitreous china to BS 3402

Compatible Products

- 1¼" unslotted wastes – see page 78
- 1¼" bottle traps – see page 80

SanCeram

Langley Rectangular Vessel Basin LLWB121

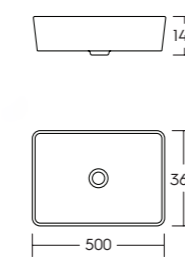

Features & Benefits

- No tap holes or overflow
- Bottom outlet for ease of maintenance
- Install onto a vanity or worktop
- Contemporary slim sided appearance

Material

- Vitreous china to BS 3402

Compatible Products

- 1¼" unslotted wastes – see page 78
- 1¼" bottle traps – see page 80

SanCeram

Langley Oval Vessel Basin
LLWB123

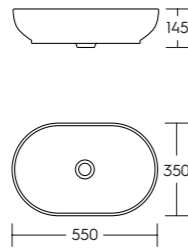

Features & Benefits

- No tap holes or overflow
- Bottom outlet for ease of maintenance
- Install onto a vanity or worktop

Material

- Vitreous china to BS 3402

Compatible Products

- 1¼" unslotted wastes – see page 78
- 1¼" bottle traps – see page 80

SanCeram

Chartham Cleaners Sink
CHSK101

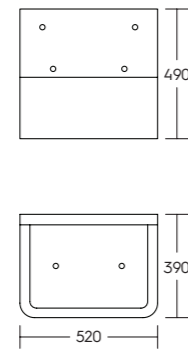

Features & Benefits

- High built in splash back
- Hard wearing and durable
- Hinged grate sold separately
- Compatible with wall mounted taps for use in cleaners areas

Fixing

- Chartham stainless steel sink legs and aluminium bearers – CHSK103N

Material

- Fireclay

Compatible Products

- Chartham stainless steel cleaners sink grate – CHSK102
- 1½" plastic resealing bottle trap – C10R
- 1½" unslotted strainer waste – TSWC109

SanCeram

Belfast Sink
S580301

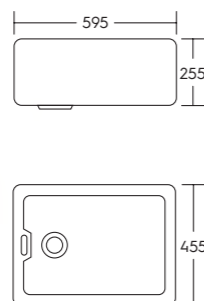

Features & Benefits

- Resistant to acids and alkalis
- Hard wearing and durable
- Compatible with wall mounted taps

Fixing

- Legs and bearers – S9250MY

Material

- Fireclay

Compatible Products

- Brackets aluminium alloy built-in, 405mm overall, 355mm stud (pair) – S921967
- 1½" slotted strainer waste – S8725AA
- 1½" plastic resealing bottle trap – C10R

Armitage
Shanks

Solid Surface Wash Trough
SCTR101



Our SanCeram Solid Surface Wash Troughs are stylish yet timeless and the perfect addition to any public or school washroom. There is a choice of profiles suitable for wall mounted or deck mounted taps, with stainless steel cantilever brackets.

Features & Benefits

- No overflow
- Single left handed 1½" waste outlet point
- Wall mounted installation
- Strong, robust and repairable material

Material

- Solid Surface

Compatible Products

- 1½" plastic resealing bottle trap – C10R
- 1½" unslotted strainer waste – TSWC109

Deck Mounted Taps

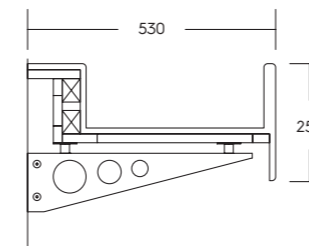

Wall Mounted Taps

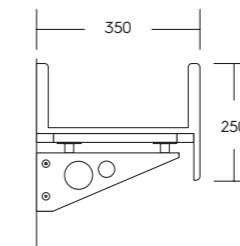

Click the button to view our full range of solid surface wash troughs online

SanCeram

The benefits of Solid Surface



High durability

Manufactured from an advanced composition of minerals and acrylic polymer, Solid Surface is extremely durable with a high resistance to cleaning products and chemicals.



Seamless joints

The use of colour matched adhesive helps give an unbroken and flowing finish.



Hygienic and easy to clean

Meeting NSF51 standards, Solid Surface is hygienic and the smooth surface stops germs harbouring and makes the material easy to clean.



Repairable

Scratches can be sanded and polished out to keep the material looking fresh. Larger chips or deep scratches can be filled and sections can even be replaced.



Fire-resistant

Solid Surface is tested to UK BS476 Class 0.



Non-porous and waterproof

Solid Surface is non-porous and 100% waterproof, enabling its use in a wide range of applications.

Our comprehensive range of Brassware includes traditional and modern taps to suit your every requirement. Whether you need Wall Mounted Taps for a commercial environment, no touch Sensor Taps for a school washroom refurbishment or Doc M taps for a DDA compliant toilet, we are confident that we have what you need.

Our range of Brassware also includes water saving taps, HBN compliant taps and designs that have anti-vandal features. We also have a selection of Tall Basin Taps, Pairs of Taps and Kitchen Taps as well as a range of bathroom Wastes and Traps.

Lever Basin Taps

Our collection of stylish, monobloc Lever Basin Taps boast easy to use operation, making them ideal for commercial, educational and domestic use. With features such as tilt and turn temperature and flow control, adjustable directional slim stream aerators and WRAS approved options, there really is a solution for every project.

Self-closing and Sensor Taps

Our collection of Self-closing Taps are ideal for commercial sanitaryware installations as well as other high usage settings. The automatic shut off ensures no excess water wastage or accidental flooding, also suited to schools and public areas. We have a selection of DDA compliant Self-closing Taps that are suitable for closed fist operation, as well as designs that are anti-vandal for high traffic, busy washrooms.

Our Self-closing Sensor Taps deliver water without touch, perfect for washrooms where hygiene and water economy are key factors. As well as the choice of battery and mains powered operation, we also have Sensor Taps that are TMV3 and WRAS approved, as well as HBN/SHTM compliant for healthcare settings.

Wall Mounted Taps

Our collection of Wall Mounted Taps are available as mixer taps or separate hot and cold bib taps. With easy to use lever operation and features such as concealed fixing plates, tilt and turn temperature and flow control and WRAS approval, they are suitable for a wide range of environments.



Icon key – Features of our products



Click the button to view our full range of Brassware online

Sensor products are becoming increasingly popular in all washrooms, they remove the need to touch surfaces where bacteria and germs can populate.

Why choose Sensor Solutions

- ✓ Deliver water without touch, perfect for washrooms where hygiene is a key factor
- ✓ With pre-mixed water blended using a standalone TMV3 valve, the water temperature is pre-set to 41 degrees, the ideal hand washing temperature to ensure maximum user hygiene and prevent scalding, perfect for public areas and schools
- ✓ Automatic shut-off ensures that water is not wasted – saving both water and money
- ✓ Sensor taps with a pre-set temperature that is kept at a constant, use less energy than one with an adjustable temperature
- ✓ For healthcare installations you can rest assure that they offer increased infection control benefits



We recommend...

Education

Our SanCeram Basin Mounted Self-closing Mixer Tap provides easy press action operation and automatic shut off ideal to save water and prevent accidental flooding.



Installed at: Cottenham Nursery

Commercial

Our SanCeram Hartley Wall Mounted Basin Mixer Tap in Chrome has a concealed fixing plate and easy to use stylish tilt and turn lever for temperature control.



Hartley Wall Mounted Basin Mixer Tap

Best all-rounder

Our SanCeram Deck Mounted Sensor Tap delivers water without touch, perfect for washrooms where hygiene and water economy are key factors.



Installed at: Dundonald Church

Short Lever Basin Taps
DLT101

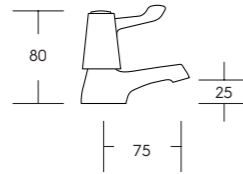

Features & Benefits

- Quarter turn function for rapid on/off operation
- Ceramic disc gives smooth operation
- Easy operation suitable for all sectors

Finish

- Chrome

Operating Pressure

- Max: 5.0 bar
- Min: 0.1 bar

Compatible Product

- TMV3 15mm temperature blending valve – SCBW113



Sandringham 21 Pair of Lever Taps
B9881AA

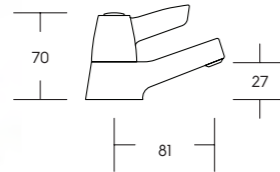

Features & Benefits

- Quarter turn function for rapid on/off operation
- Ceramic disc technology gives smooth operation
- Easy operation for all sectors

Finish

- Chrome

Operating Pressure

- Max: 10.0 bar
- Min: 0.2 bar

Compatible Product

- TMV3 15mm temperature blending valve – SCBW113



Pair of Insignia Lever Taps
INS101

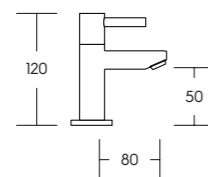

Features & Benefits

- Quarter turn function for rapid on/off operation
- Ceramic disc gives smooth operation
- Modern design

Finish

- Chrome

Operating Pressure

- Max: 5.0 bar
- Min: 0.2 bar

Compatible Product

- TMV3 15mm temperature blending valve – SCBW113



Contour 21+ Pair of Basin Pillar Taps
BC123AA

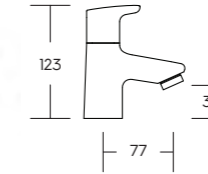

Features & Benefits

- Water saving 4ltr/min at 3 bar pressure
- Ceramic disc gives smooth operation
- Self-draining spout for increased hygiene

Finish

- Chrome

Operating Pressure

- Max: 10.0 bar
- Min: 0.5 bar

Compatible Product

- TMV3 15mm temperature blending valve – SCBW113



Chartham Mono Basin Mixer Tap
SCBW101

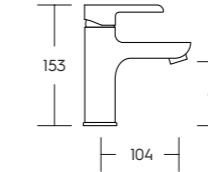

Features & Benefits

- Ceramic cartridge for smooth operation
- Adjustable directional slim stream aerator
- Complete with press top waste
- Supplied with flexi-tails
- 7ltr/min flow regulator included

Finish

- Chrome

Operating Pressure

- Max: 5.0 bar
- Min: 0.2 bar

Compatible Product

- TMV3 15mm temperature blending valve – SCBW113



Ethos Mono Basin Mixer Tap
ETH113

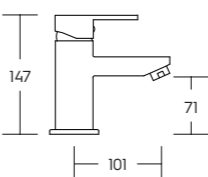

Features & Benefits

- Tilt and turn temperature and flow control
- Ceramic cartridge for smooth operation
- Complete with press top waste
- Supplied with flexi-tails

Finish

- Chrome

Operating Pressure

- Max: 5.0 bar
- Min: 0.3 bar

Compatible Product

- TMV3 15mm temperature blending valve – SCBW113



Langley Mono Basin Mixer Tap
LLBW106

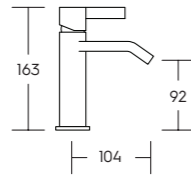

Features & Benefits

- Tilt and turn temperature and flow control
- Water flow aerator
- Includes pop-up waste
- Supplied with flexi-tails
- Minimalistic design

Finish

- Chrome

Operating Pressure

- Max: 5.0 bar
- Min: 0.2 bar

Compatible Product

- TMV3 15mm temperature blending valve – SCBW113

SanCeram

SanCeram Sequential TMV3 Mixer Tap
SCBW120

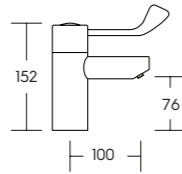

Features & Benefits

- Long sequential lever operation
- Factory set temperature of 43°C
- TMV3 approved
- Safe touch body
- Self draining spout
- Supplied with flexi-tails

Finish

- Chrome

Operating Pressure

- Max: 10.0 bar
- Min: 0.2 bar

Compatible Product

- Copper tails and adaptors – SCBW115

SanCeram



Hartley Basin Mixer Tap – Chrome
HABW101

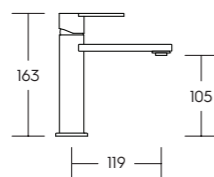

Features & Benefits

- Tilt and turn temperature and flow control
- Adjustable directional slim stream aerator
- Supplied with flexi tails
- Minimalistic slim design
- Available in 3 finishes

Finish

- Chrome

Operating Pressure

- Max: 5.0 bar
- Min: 0.5 bar

Compatible Product

- TMV3 15mm temperature blending valve – SCBW113

Product options

- Hartley basin mixer tap in brushed nickel – HABW101N
- Hartley basin mixer tap in matt black – HABW101B

SanCeram

Adore Mini Basin Mixer
ADORE313

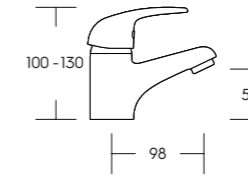

Features & Benefits

- Tilt and turn temperature and flow control
- Ceramic cartridge gives smooth operation
- Mini compact design ideal for use with small basins

Finish

- Chrome

Operating Pressure

- Max: 5.0 bar
- Min: 0.3 bar

Compatible Product

- TMV3 15mm temperature blending valve – SCBW113



Insignia Lever Basin Mixer
INS113

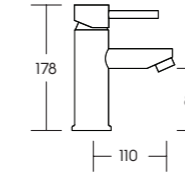

Features & Benefits

- Tilt and turn temperature and flow control
- Ceramic cartridge gives smooth operation
- Press-top waste
- Supplied with flexi-tails

Finish

- Chrome

Operating Pressure

- Max: 5.0 bar
- Min: 0.3 bar

Compatible Product

- TMV3 15mm temperature blending valve – SCBW113



Swoop MK2 Basin Mixer Tap
SWO2113

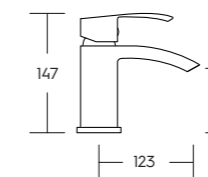

Features & Benefits

- Tilt and turn temperature and flow control
- Ceramic cartridge gives smooth operation
- Includes press-top waste
- Supplied with flexi-tails
- Modern angular design

Finish

- Chrome

Operating Pressure

- Max: 5.0 bar
- Min: 0.3 bar

Compatible Product

- TMV3 15mm temperature blending valve – SCBW113



Vision Lever Basin Mixer Tap
VSN113

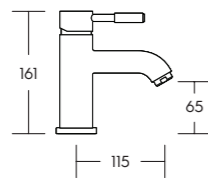

Features & Benefits

- Tilt and turn temperature and flow control
- Ceramic cartridge gives smooth operation
- Includes press-top waste
- Supplied with flexi-tails

Finish

- Chrome

Operating Pressure

- Max: 5.0 bar
- Min: 0.3 bar

Compatible Product

- TMV3 15mm temperature blending valve – SCBW113



SanCeram Basin Mounted Self-closing Mixer Tap SCBW106

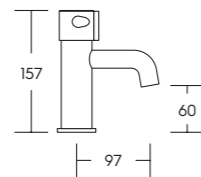

Features & Benefits

- Self-closing function ensures no excess water wastage
- Water saving with a 15 second (± 3 sec) flow time at 1 bar pressure
- Temperature adjustment
- Easy to operate handle
- Supplied with flexi-tails

Finish

- Chrome

Operating Pressure

- Max: 5.0 bar
- Min: 0.5 bar

Compatible Product

- TMV3 15mm temperature blending valve – SCBW113
- Copper tails – SCBW115



SanCeram

Avon 21 Press Action Mixer Tap
B8263AA

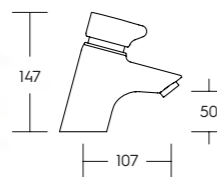

Features & Benefits

- Self-closing for water saving
- 3.7ltr/min flow regulator included
- Adjustable timed shut off
- Temperature adjustment
- Supplied with flexi-tails

Finish

- Chrome plated brass

Operating Pressure

- Max: 10.0 bar static
- Min: 0.5 bar dynamic

Compatible Product

- TMV3 15mm temperature blending valve – SCBW113



Armitage
Shanks

SanCeram Self-closing Toggle Tap
SCBW107

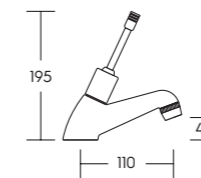

Features & Benefits

- Easy, smooth multi-directional toggle lever operation
- Self-closing for water saving
- Water saving with a 15 second (± 3 sec) flow time at 1 bar pressure
- Ideal for users with limited dexterity

Finish

- Chrome

Operating Pressure

- Max: 10.0 bar
- Min: 0.2 bar

Compatible Product

- TMV3 15mm temperature blending valve – SCBW113



SanCeram

SanCeram Basin Mounted Self-closing Tap SCBW121

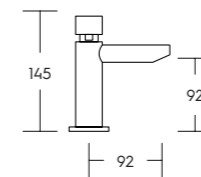

Features & Benefits

- Self-closing for water saving
- Water saving with a 15 second (± 3 sec) flow time at 3 bar pressure
- Blue and red indices provided to identify the water temperature
- 5ltr/min flow regulator included

Finish

- Chrome

Operating Pressure

- Max: 6.0 bar
- Min: 1.0 bar

Compatible Product

- TMV3 15mm temperature blending valve – SCBW113



SanCeram

Pair of Contemporary Press Action Taps SCBW124

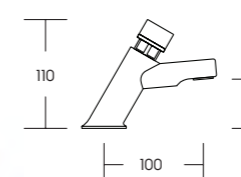

Features & Benefits

- Simple press action operation
- Self-closing for water saving
- Water saving with a 15 second (± 3 sec) flow time at 1 bar pressure

Finish

- Chrome

Operating Pressure

- Max: 10.0 bar
- Min: 0.5 bar

Compatible Product

- TMV3 15mm temperature blending valve – SCBW113



SanCeram

Avon 21 Pair of Press Action Taps
B8267AA



- Features & Benefits**
- Press action operation
 - Adjustable run time
 - Self-closing for water saving
 - 3.7ltr/min flow at 3 bar pressure
 - Anti-vandal

Finish

- Chrome

Operating Pressure

- Max: 5.0 bar
- Min: 0.1 bar

Compatible Product

- TMV3 15mm temperature blending valve – SCBW113



Armitage
Shanks

Sandringham 21 Self-closing Pillar Taps
S0672AA



- Features & Benefits**
- Press action operation
 - Self-closing for water saving
 - Typical run time of 12-16 seconds
 - 4ltr/min flow regulators supplied

Finish

- Chrome

Operating Pressure

- Max: 5.0 bar
- Min: 1.0 bar

Compatible Product

- TMV3 15mm temperature blending valve – SCBW113



Armitage
Shanks

Pair of Press Action Taps
NCT001



- Features & Benefits**
- Press action operation
 - Self-closing for water saving
 - Typical flow time 10 seconds
 - Deck mounted

Finish

- Chrome

Operating Pressure

- Max: 3.0 bar
- Min: 0.2 bar

Compatible Product

- TMV3 15mm temperature blending valve – SCBW113



Deva
by METHVEN

SanCeram Deck Mounted Sensor Tap
SCBW119



- Features & Benefits**
- Hygienic touch free operation
 - For pre-mixed water
 - Proximity sensor built into tap
 - Pre-set sensor range with adjustment
 - Battery powered
 - 24 hour built in hygiene flush to prevent stagnation
 - 6ltr/min flow regulator included

Finish

- Chrome plated brass

Operating Pressure

- Max: 8.0 bar static
- Min: 1.0 bar dynamic

Compatible Product

- Transformer to mains power – SCBW116
- TMV3 15mm temperature blending valve – SCBW113



SanCeram

Sensorflow 21 Deck Mounted Tap - Mains Powered A4171AA



- Features & Benefits**
- Hygienic touch free operation
 - For pre-mixed water
 - 3.7ltr/min flow at 3 bar pressure
 - Mains powered

Finish

- Chrome

Operating Pressure

- Max: 5.0 bar
- Min: 0.2 bar

Compatible Extras

- TMV3 15mm temperature blending valve – SCBW113

Product Options

- Link powered – A4172AA
- Battery powered – A4122AA



Armitage
Shanks

Sensorflow 21 Compact Deck Mounted Tap - Mains Powered A4852AA



- Features & Benefits**
- Hygienic touch free operation
 - For pre-mixed water
 - Proximity sensor built into tap
 - 3.7ltr/min flow at 3 bar pressure

Finish

- Chrome

Operating Pressure

- Max: 5.0 bar
- Min: 0.2 bar

Compatible Extras

- TMV3 15mm temperature blending valve – SCBW113

Product Options

- Link powered – A4853AA
- Battery powered – A4851AA



Armitage
Shanks

Deck Mounted Temperature Adjustment Sensor Tap SENSOR6BT

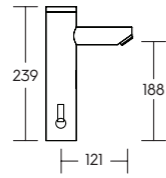

Features & Benefits

- Hygienic touch free operation
- Proximity sensor
- Temperature adjustment lever
- Battery powered, requires 4 x AA batteries
- Moisture and water resistant control box

Finish

- Chrome

Operating Pressure

- Max: 5.0 bar
- Min: 0.5 bar

Compatible Product

- TMV3 15mm temperature blending valve – SCBW113



Aquarius Wall Mounted 150mm Sensor Tap Spout AT02001

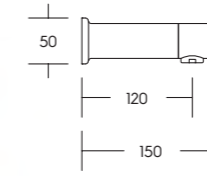

Features & Benefits

- Hygienic touch free operation
- For pre-mixed water
- Tap spout only – no electronics
- Requires station control kit to operate
- Stainless steel construction

Finish

- Stainless steel

Operating Pressure

- Max: 6.0 bar static
- Min: 1.0 bar dynamic

Compatible Products

- Single station battery powered kit – AT00001
- Single Station mains powered kit – AT00002
- Hand held programmer – AC01001
- TMV3 15mm temperature blending valve – SCBW113



Standard Sensor Basin Tap SENSOR1D

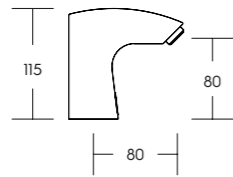

Features & Benefits

- Hygienic touch free operation
- For pre-mixed water
- Proximity sensor
- Scratch resistant sensor window
- Battery backup requires 4 x AA batteries
- Moisture and water resistant control box

Finish

- Chrome

Operating Pressure

- Max: 5.0 bar
- Min: 0.5 bar

Compatible Product

- TMV3 15mm temperature blending valve – SCBW113



Wall Mounted Sensor Tap SENSOR9W

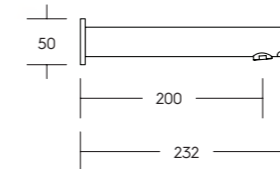

Features & Benefits

- Hygienic touch free operation
- Mains powered with battery back up
- Battery backup requires 4 x AA batteries
- Scratch resistant sensor window
- Moisture and water resistant control box

Finish

- Chrome

Operating Pressure

- Max: 5.0 bar
- Min: 0.5 bar

Compatible Extras

- TMV3 15mm temperature blending valve – SCBW113



Aquarius A45 Sensor Tap Spout AT03011

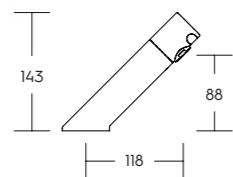

Features & Benefits

- Hygienic touch free operation
- For pre-mixed water
- Tap spout only – no electronics
- Requires station control kit to operate
- Stainless steel construction

Finish

- Stainless steel

Operating Pressure

- Max: 6.0 bar
- Min: 1.0 bar

Compatible products

- Single station battery powered kit – AT00001
- Single station mains powered kit – AT00002
- Hand held programmer – AC01001
- TMV3 15mm temperature blending valve – SCBW113



Tall Sensor Basin Tap SENSOR3D

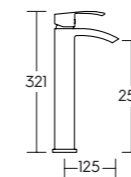

Features & Benefits

- Hygienic touch free operation
- Proximity sensor
- Battery back up requires 4 x AA batteries
- Mains powered with battery back up
- Scratch resistant sensor window
- Moisture and water resistant control box

Finish

- Chrome

Operating Pressure

- Max: 5.0 bar
- Min: 0.5 bar

Compatible Product

- TMV3 15mm temperature blending valve – SCBW113



Swoop MK2 Tall Basin Mixer Tap
SWO2113EX

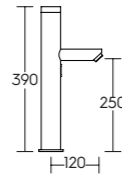

Features & Benefits

- Tilt and turn temperature and flow control
- Ceramic cartridge for smooth operation
- Supplied with flexi-tails
- Modern angular design

Finish

- Chrome

Operating Pressure

- Max: 5.0 bar
- Min: 0.3 bar

Compatible Extras

- TMV3 15mm temperature blending valve – SCBW113



Hartley Tall Basin Mixer Tap - Chrome
HABW102

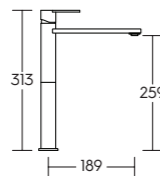

Features & Benefits

- Tilt and turn temperature and flow control
- Adjustable directional slim stream aerator
- Supplied with flexi-tails
- Minimalistic slim design

Finish

- Chrome

Operating Pressure

- Max: 5.0 bar
- Min: 0.5 bar

Compatible Products

- TMV3 15mm temperature blending valve – SCBW113

Product Options

- Hartley tall basin mixer tap in brushed nickel – HABW102N
- Hartley tall basin mixer tap in matt black – HABW102B

SanCeram

Langley Tall Mono Basin Mixer Tap
LLBW107

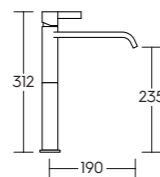

Features & Benefits

- Tilt and turn temperature and flow control
- Flow straightener
- Supplied with flexi-tails and pop-up waste
- Minimalistic design

Finish

- Stainless steel

Operating Pressure

- Max: 5.0 bar
- Min: 1.0 bar

Compatible products

- TMV3 15mm temperature blending valve – SCBW113

SanCeram

Deva Lever Action 6 Inch Bib Tap
DLV095

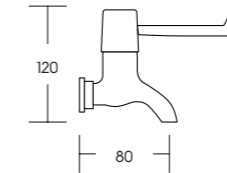

Features & Benefits

- Quarter turn function for rapid on/off operation with 6 inch levers
- Ceramic discs ensure smooth on/off operation
- Wall mounted

Finish

- Stainless steel

Operating Pressure

- Max: 5.0 bar
- Min: 0.1 bar

Compatible products

- 45mm wall extensions for exposed pipework – 095WALLEXT
- 100mm wall extensions – ID0063
- Bib tap wall connector – ID0061

Product Options

- Lever action bib taps – DLT095



Chartham Deck Mounted Bath Filler Tap
SCBW102

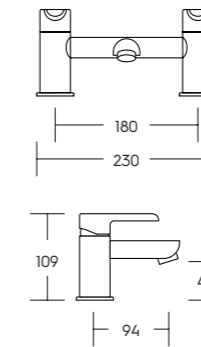

Features & Benefits

- Dual levers for flow and temperature control
- Quarter turn levers
- Ceramic disc for smooth operation
- Deck mounted

Finish

- Chrome

Operating Pressure

- Max: 5.0 bar
- Min: 0.3 bar



SanCeram

Chartham Deck Mounted Bath/Shower Mixer
SCBW118

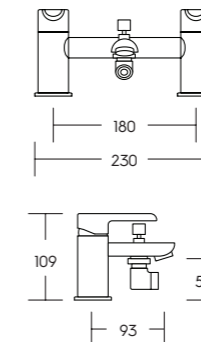

Features & Benefits

- Dual levers for flow and temperature control
- Quarter turn levers
- Ceramic discs ensure smooth operation
- Supplied with 9ltr/min flow regulator
- Includes shower patented Satinjet shower head
- 1.5m easy clean hose and wall bracket
- Single mode handset

Finish

- Stainless steel

Operating Pressure

- Max: 5.0 bar
- Min: 0.5 bar



SanCeram

SanCeram Healthcare TMV3 Wall Mounted Lever Tap – Removable Spout SCBW122

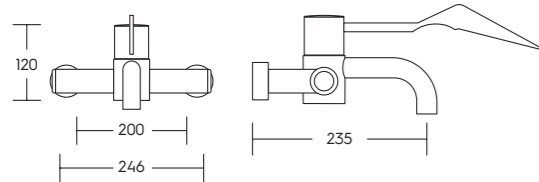

Features & Benefits

- TMV3 approved thermostatic control
- Pre-set factory temperature: 41°C
- Safe touch body
- Spout can be removed for autoclaving
- Sterilisation function for the complete tap
- Integral isolation valves
- Isolation, check valves and filters accessible insitu
- Smooth internal surfaces
- Flow rate regulated at 10ltr/min max
- Long paddle lever

Finish

- Chrome

Operating Pressure

- Max: 10.0 bar static
- Min: 0.1 bar

Technical Specification

- Max inlet temperature: 85°C

Additional Products

- Purge kit for healthcare clinical taps – SCBW117



SanCeram

SanCeram Healthcare TMV3 Wall Mounted Sensor Tap – Removable Spout SCBW123

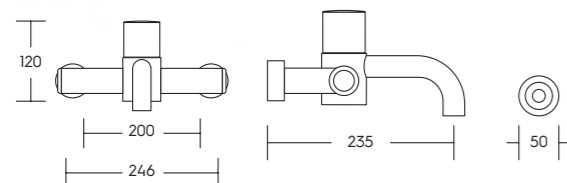

Features & Benefits

- TMV3 approved thermostatic control
- Pre-set factory temperature: 41°C
- Safe touch body
- Spout can be removed for autoclaving
- Sterilisation function for the complete tap
- Integral isolation valves
- Isolation, check valves and filters accessible insitu
- Smooth internal surfaces
- Flow rate regulated at 10ltr/min max
- Remote sensor operated
- Battery powered
- 24 hour hygiene flush
- Hygienic touch free operation

Finish

- Chrome

Operating Pressure

- Max: 10.0 bar static
- Min: 0.1 bar

Technical Specification

- Max inlet temperature: 85°C

Additional Products

- Purge kit for healthcare clinical taps – SCBW117
- Transformer for mains power – SCBW116



SanCeram

Markwik 21+ Panel Mounted Thermostatic Basin Mixer Tap A6682AA

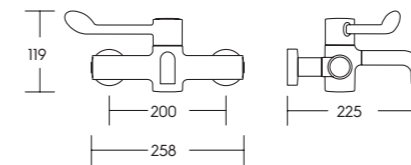

Features & Benefits

- TMV3 approved thermostatic control
- Pre-set factory temperature: 40°C
- Spout can be removed for autocleaning
- Sterilisation function for the complete tap
- Integral isolation valves
- Isolation, check valves and filters accessible insitu
- Smooth internal surfaces
- BioGuard outlet
- Flow rate regulated at 10ltr/min max
- Long paddle lever

Finish

- Chrome

Operating Pressure

- Max: 10.0 bar static
- Min: 0.6 bar

Technical Specification

- Max inlet temperature: 65°C

Additional Products

- Markwik 21+ purging kit for panel mounted thermostatic mixers – A6899NU

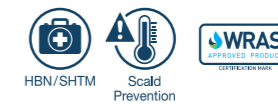

Armitage Shanks

Markwik 21+ Panel Mounted Thermostatic Basin Mixer Tap, with Time Flow Sensor A6737AA

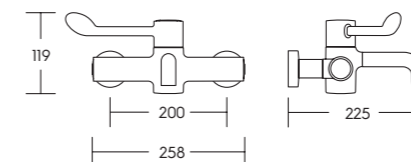

Features & Benefits

- TMV3 approved thermostatic control
- Pre-set factory temperature: 40°C
- Spout can be removed for autocleaning
- Sterilisation function for the complete tap
- Integral isolation valves
- Isolation, check valves and filters accessible insitu
- Smooth internal surfaces
- BioGuard outlet
- Flow rate regulated at 10ltr/min max
- Timed flow sensor operation
- Hygienic touch free operation

Finish

- Chrome

Operating Pressure

- Max: 10.0 bar static
- Min: 0.6 bar

Technical Specification

- Max inlet temperature: 65°C

Additional Products

- Markwik 21+ purging kit for panel mounted thermostatic mixers – A6899NU



Armitage Shanks

SanCeram TMV3 15mm Valve
SCBW113

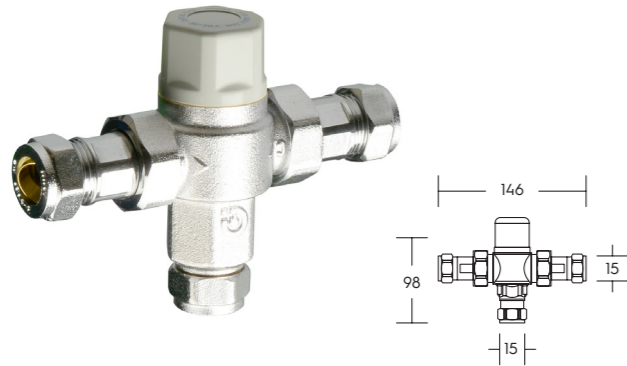

Features & Benefits

- TMV3 approved
- One piece cartridge for easy maintenance and replacement
- Integral check valves and strainers
- Building regulation part G compliant

Finish

- Chrome

Operating Pressure

- Max: 5.0 bar dynamic
- Min: 0.2 bar dynamic

Technical Specification

- Max inlet temperature: 85°C
- Temperature adjustment range: 30°C to 50°C
- Max pressure inlet differential: 5:1

Product Options

- TMV3 22mm – SCBW114



SanCeram

1¼” Strainer Waste – Slotted
TSCW101



Features & Benefits

- Helps to prevent accidental flooding due to running tap
- Available with slotted and unslotted tails
- Supplied with fixing nut and sealing washer

Finish

- Chrome plated

Product Options

- 1¼” strainer waste unslotted – TSCW102
- 1½” strainer waste unslotted – TSCW109

SanCeram

1¼” Swivel Waste – Slotted
TSCW103



Features & Benefits

- Complete with a captive spinning disk
- Supplied with fixing nut and sealing washer
- Anti-vandal
- Available with slotted and unslotted tails

Finish

- Chrome plated

Product Options

- 1¼” swivel waste unslotted – TSCW104

SanCeram

1¼” Plug and Chain Waste – Slotted
TSCW105



Features & Benefits

- Complete rubber plug and chain with securing bolt
- Supplied with fixing nut and sealing washer
- Available with slotted and unslotted tails

Finish

- Chrome plated

Product Options

- 1¼” plug and chain waste unslotted – TSCW106

SanCeram

1¼” Press Top Waste – Slotted
TSCW107



Features & Benefits

- Complete with chrome press top
- Supplied with fixing nut and sealing washer
- Available with slotted and unslotted tails

Finish

- Chrome plated

Product Options

- 1¼” click-clack waste unslotted – TSCW108

SanCeram

1¼” Ceramic Topped Waste – Slotted
TSCW120



Features & Benefits

- Press top operation
- Supplied with fixing nut and sealing washer
- Available with slotted or unslotted tails

Finish

- Chrome plated

Product Options

- Ceramic topped unslotted waste – TSCW121

SanCeram

1¼” Plastic Resealing Bottle Trap
A10R



Features & Benefits

- Plastic construction
- Connects to a standard 32mm waste pipe
- Fits all 1¼” basin wastes
- Ensures retention of an adequate water seal, even under extreme syphonic conditions

Finish

- White plastic

Product Options

- 1½” plastic bottle trap – C10R

*Armitage
Shanks*

1¼” Chrome Plated Bottle Trap
TSWC112



Features & Benefits

- Durable chrome plated brass body
- Connects to a standard 32mm waste pipe
- Modern appearance

Finish

- Chrome plated

SanCeram

1¼” Modern Chrome Plated Bottle Trap
TSWC114



Features & Benefits

- Durable chrome plated brass body
- Connects to a standard 32mm waste pipe
- Modern appearance

Finish

- Chrome plated

SanCeram

What better way to see our range than in some of our Case Studies



Click the button to view our full range of Case Studies online

Document M (Doc M) of the building regulations provides guidance on providing access to and the use of buildings for disabled people. It helps ensure that washroom facilities are available for all regardless of the nature of the building.

In conjunction with the Equality Act (updated 2010) which requires that every business providing goods or services to the public must take reasonable steps to ensure disabled people are not at a disadvantage compared to non-disabled people when accessing all aspects of their premises, in short it gives 'access for all'.

You will also find requirements for visual impaired users which state that a 30 point LRV difference should be allowed for between the critical surfaces, in the washroom environment, typically between the walls, floor, grab rails and sanitaryware fittings.

BS 8300-2 2018 must also be considered and gives guidance on the size, layout and fittings required in washroom facilities provided for disabled users.

Our Doc M solutions have been designed to ensure compliancy whilst providing users with a safe, practical and modern accessible washroom. All packs comprise of WCs and seats, cisterns, hand-rinse basins, mixer taps and appropriate grab rails.

Available in left and right handing, our WC Doc M packs come in various colours and styles including those with stainless steel and chrome grab rails. From our Close Coupled WC Doc M range that is perfect for commercial accessible washrooms, through to our Sensor range that is ideal for the more luxurious project. There are also rimless flush design WCs to ensure ultimate hygiene.

Within our Doc M range we also offer compliant shower packs and a selection of grab rails. You can be assured that all components are fit for purpose, easy to maintain and fully compliant.

For further information on our Doc M range please see our Doc M Solutions brochure.



Icon key – Features of our products

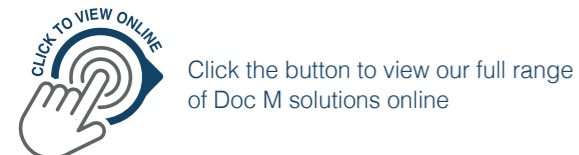

Key features of a Doc M Pack

The primary characteristics of a modern washroom suitable for disabled use are shown in the example to the right. Fit for purpose is essential and sanitaryware items must be easy to operate, tailored to a specific need and correctly positioned.

- 1 Grab rails available in a range of styles and colours
- 2 Hinged support arm suitable for loads up to 120kg
- 3 Spatula style lever flush for ease of use
- 4 Dual flush cistern supplied with 4.5ltr effective flush volume
- 5 Solid stainless steel seat fixing bar for extra security
- 6 WC seats available in a range of colours
- 7 Sequential basin mixer for ease of use – TMV3 approved controlled tap to prevent scalding
- 8 Tap position to be closest to the WC
- 9 Basin without overflow to prevent bacteria build up
- 10 Basin supplied with strainer waste to allow washing under running water
- 11 WC pan designed with required extended projection and raised height to meet regulations without the need for spacer boxes
- 12 Rimless flush design to WC pans for the ultimate in hygiene
- 13 WC available as close coupled, back to wall or wall hung



We recommend...

Increased hygiene

Our SanCeram Sensor WC Doc M Pack is ideal for the more hygiene conscious accessible washroom with a Sensor Tap and Sensor Flush for ultimate hygiene control.

Shower

Our SanCeram Concealed Shower Doc M Pack with White Grab Rails is LABC approved as well as Doc M and DDA Compliant.

Best all-rounder

Our SanCeram Close Coupled Doc M Pack is perfect for any accessible washroom. Including everything you need, you can also tailor colours to your individual decor to ensure that LRV requirements are met.



SanCeram Sensor WC Doc M Pack



Installed at: Acre Mills Hospital

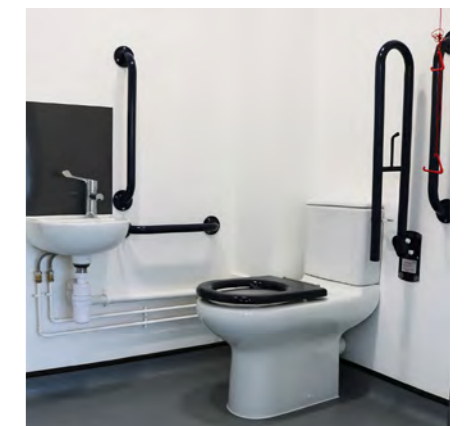

Installed at: Stanborough School

SanCeram Essentials WC Doc M Pack SCDMEW



SanCeram



Our SanCeram Essentials Doc M range is ideal for when you need the essential items and nothing more. You can rest assure that compliance and durability will all be matched for your wheelchair accessible washroom.

Features & Benefits

- Close coupled WC Doc M compliant universal pack
- Toilet seat with adjustable buffers
- Two tap hole basin for flexibility of handing
- Bottom outlet for ease of maintenance
- Sequential lever mixer tap (TMV3 valve sold separately)
- Steel powder-coated grab rails
- LABC approved

CODE	COLOUR
SCDMEW	White
SCDMEB	Blue
SCDMEG	Dark Grey

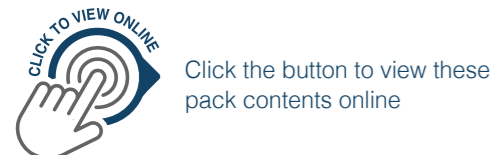

See page 91 for typical layouts

SanCeram Close Coupled WC Doc M Pack SCDMCCLW



SanCeram



Our SanCeram Close Coupled WC Doc M range includes everything you need to ensure your facilities are fit for purpose, with the added bonus of tailoring colours to your decor to ensure that LRV requirements are met.

Features & Benefits

- Close coupled extended projection, raised height WC with lever flush
- Rimless WC ideal for water saving and increased hygiene
- TMV3 approved basin mixer to help prevent scalding
- LABC approved

CODE	COLOUR	HANDING
SCDMCCLW	White	Left
SCDMCCLB	Blue	Left
SCDMCCLG	Dark Grey	Left
SCDMCCLSS	Stainless Steel	Left
SCDMCCRW	White	Right
SCDMCCRB	Blue	Right
SCDMCCRG	Dark Grey	Right
SCDMCCRSS	Stainless Steel	Right

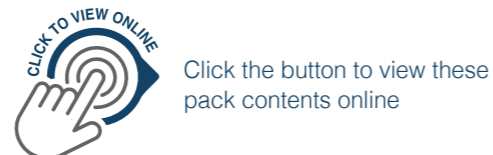

See page 91 for typical layouts

Contour 21+ Close Coupled WC Doc M Pack S0683AC



Armitage Shanks



Armitage Shanks Contour 21+ Close Coupled WC Doc M pack, comes with everything needed to provide economical yet functional Doc M and DDA compliant washroom facilities.

Features & Benefits

- Close coupled Contour 21+ raised height WC
- Water saving cistern with spatula lever
- TMV3 approved basin mixer to help prevent scalding
- LABC approved

CODE	COLOUR	HANDING
S0683AC	White	Left
S0683LI	Blue	Left
S0683LJ	Grey	Left
S0683RN	Dark Grey	Left
S0683GQ	Red	Left
S0683MY	Stainless Steel	Left
S0684AC	White	Right
S0684LI	Blue	Right
S0684LJ	Grey	Right
S0684RN	Dark Grey	Right
S0684GQ	Red	Right
S0684MY	Stainless Steel	Right

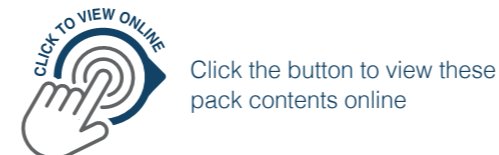

See page 91 for typical layouts

SanCeram Back To Wall WC Doc M Pack SCDMBTWLW

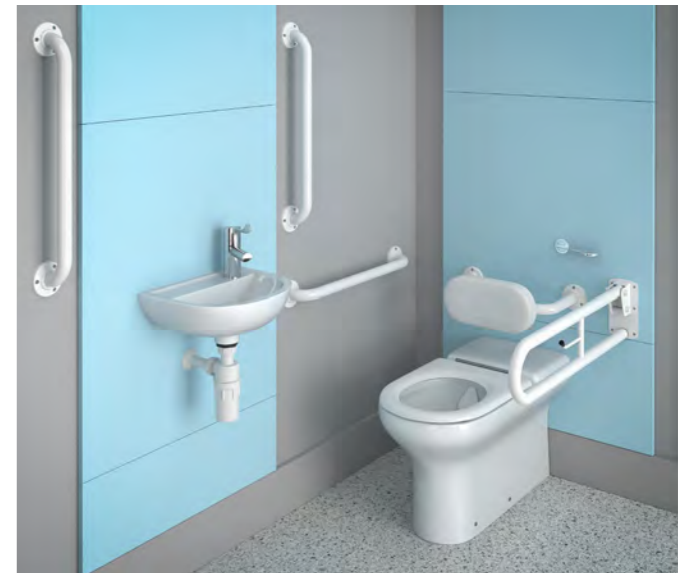

SanCeram



Our SanCeram Back To Wall WC Doc M range offers multiple colour options for the grab rails, back rest and seat, so your washroom can be truly customised whilst still being compliant.

Features & Benefits

- Robust back to wall WC with extended projection
- Rimless WC ideal for water saving and increased hygiene
- TMV3 approved basin mixer to help prevent scalding
- Co-ordinating back rest to the grab rails, supplied in white
- LABC approved

CODE	COLOUR	HANDING
SCDMBTWLW	White	Left
SCDMBTWLB	Blue	Left
SCDMBTWLG	Dark Grey	Left
SCDMBTWLSS	Stainless Steel	Left
SCDMBTWLC	Chrome	Left
SCDMBTWRW	White	Right
SCDMBTWRB	Blue	Right
SCDMBTWRG	Dark Grey	Right
SCDMBTWRSS	Stainless Steel	Right
SCDMBTWRC	Chrome	Right

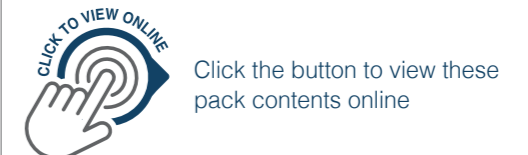

See page 91 for typical layouts

Contour 21+ Back to Wall WC Doc M Pack S0685AC



Armitage Shanks



Armitage Shanks Contour 21+ Back to Wall WC Doc M pack, at 480mm high the WC is fed by a cistern hidden by block-work or panelling to minimise clutter and maximise hygiene.

Features & Benefits

- Rimless WC for increased hygiene and easy cleaning
- Concealed 2 cistern 4.5 or 6ltr single flush with spatula lever
- TMV3 approved basin mixer to help prevent scalding
- LABC approved

CODE	COLOUR	HANDING
S0685AC	White	Left
S0685LI	Blue	Left
S0685LJ	Grey	Left
S0685RN	Dark Grey	Left
S0685GQ	Red	Left
S0685MY	Stainless Steel	Left
S0686AC	White	Right
S0686LI	Blue	Right
S0686LJ	Grey	Right
S0686RN	Dark Grey	Right
S0686GQ	Red	Right
S0686MY	Stainless Steel	Right



Click the button to view these pack contents online

See page 91 for typical layouts

SanCeram Wall Hung WC Doc M Pack SCDMWHLSS



SanCeram



Our SanCeram Wall Hung WC Doc M range offers you a choice of stylish grab rails alongside a metal back rest – resulting in a modern accessible washroom that ticks all the boxes for both accessibility and aesthetics.

Features & Benefits

- Extended projection wall hung WC to assist with cleaning
- TMV3 approved basin mixer to help prevent scalding
- Aesthetically pleasing metal bottle trap
- Grab rails supplied in stainless steel or chrome

CODE	COLOUR	HANDING
SCDMWHLSS	Stainless Steel	Left
SCDMBWHLC	Chrome	Left
SCDMBWHRSS	Stainless Steel	Right
SCDMBWHRC	Chrome	Right



Click the button to view these pack contents online

See page 91 for typical layouts

Contour 21+ Wall Hung WC Doc M Pack S6972MY



Armitage Shanks



Armitage Shanks Contour 21+ Wall Mounted WC Doc M pack, with stainless steel or chrome grab rails this pack is ideal for the more luxurious accessible washroom.

Features & Benefits

- Wall mounted rimless WC for increased hygiene and easy cleaning
- Dual flush push plate to promote water saving
- TMV3 approved basin mixer to help prevent scalding
- LABC approved

CODE	COLOUR	HANDING
S6972MY	Stainless Steel	Left
S6972AA	Chrome	Left
S6973MY	Stainless Steel	Right
S6973AA	Chrome	Right



Click the button to view these pack contents online

See page 91 for typical layouts

SanCeram Sensor WC Doc M Pack SCDMBTWLSSS



SanCeram

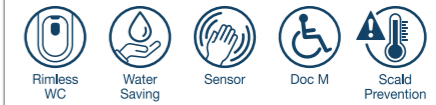

Our SanCeram Sensor Doc M range is ideal for the more luxurious accessible washroom with the added benefit of a touch free flush and tap for increased hygiene. With multiple choices for the WC and grab rails, there are plenty of options for this distinctive Doc M solution.

Features & Benefits

- Rimless WC ideal for water saving and increased hygiene
- Sensor tap and sensor flush for ultimate hygiene control
- TMV3 approved under basin thermostatic mixer valve
- Co-ordinating back rest supplied in metal
- Grab rails supplied in stainless steel or chrome

CODE	WC TYPE	COLOUR	HANDING
SCDMBTWLSSS	Back to Wall	Stainless Steel	Left
SCDMBTWRSSS	Back to Wall	Stainless Steel	Right
SCDMBTWLSC	Back to Wall	Chrome	Left
SCDMBTWRSC	Back to Wall	Chrome	Right
SCDMWHLSSS	Wall Hung	Stainless Steel	Left
SCDMWHRSSS	Wall Hung	Stainless Steel	Right
SCDMWHLSC	Wall Hung	Chrome	Left
SCDMWHRSC	Wall Hung	Chrome	Right



Click the button to view these pack contents online

See page 91 for typical layouts

Sensorflow Wall Mounted WC Doc M Pack S6986AA



Armitage Shanks

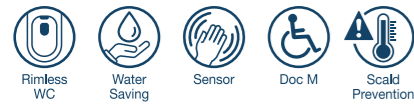

Armitage Shanks Sensorflow Wall Mounted WC Doc M pack with chrome grab rails is ideal for the more hygiene conscious accessible washroom.

Features & Benefits

- Wall mounted rimless WC for increased hygiene and easy cleaning
- Sensor flush ideal to reduce touch points within the washroom
- Water saving delay fill 4 or 4.5ltr delay fill Sensorflow toilet cistern
- TMV3 approved underbasin thermostatic mixer valve and sensor activated washbasin mixer
- LABC approved

CODE	WC TYPE	COLOUR	HANDING
S6986AA	Wall Hung	Chrome	Left
S6987AA	Wall Hung	Chrome	Right



Click the button to view these pack contents online

See page 91 for typical layouts

Doc M Contour 21+ Peninsular Care Pack S0682AC



Armitage Shanks



Armitage Shanks Doc M Contour 21+ Peninsular Care Pack, comes with a larger washbasin to aid personal washing and a raised height and extended projection toilet pan for added comfort.

Features & Benefits

- Close coupled rimless WC for increased hygiene and easy cleaning
- Water saving delay fill 4.5ltr cistern
- TMV3 approved basin mixer tap to help prevent scalding
- LABC approved

CODE	COLOUR
S0682AC	White
S0682LI	Blue
S0682RN	Dark Grey



Click the button to view these pack contents online

See page 91 for typical layouts

Shower Doc M Pack SCDMSHCWH



SanCeram



Our SanCeram Shower Doc M Pack comes in a selection of colours and with either an exposed or concealed shower valve and is Doc M and DDA compliant.

Features & Benefits

- TMV3 approved thermostatic shower valve to help prevent scalding
- Fold down seat and backrest
- Co-ordinating grab rails and shower curtain
- LABC approved

CODE	STYLE	COLOUR
SCDMSHCWH	Concealed	White
SCDMSHCBL	Concealed	Blue
SCDMSHCGR	Concealed	Dark Grey
SCDMSHCSS	Concealed	Stainless Steel
SCDMSHEWH	Exposed	White
SCDMSHEBL	Exposed	Blue
SCDMSHEGR	Exposed	Dark Grey
SCDMSHESS	Exposed	Stainless Steel



Click the button to view these pack contents online

See page 91 for typical layouts

Contour 21 Doc M Shower Room Pack S6960AC



Armitage Shanks



Armitage Shanks Contour 21 Doc M Shower Room Pack with folding shower seat and back support for ambulant shower areas.

Features & Benefits

- Doc M compliant shower pack with concealed shower valve
- Thermostatic shower valve TMV3 approved to help prevent scalding
- LABC approved

CODE	STYLE	COLOUR
S6960AC	Concealed	White
S6960LI	Concealed	Blue
S6960LJ	Concealed	Grey
S6960RN	Concealed	Dark Grey
S6960MY	Concealed	Stainless Steel



Click the button to view these pack contents online

See page 91 for typical layouts

Accessible Ensuite Shower Pack
SCESH101



SanCeram



Our SanCeram Accessible Ensuite Shower Pack has been designed to provide you with everything you need for your residential, hotel and care home shower facility.

Features & Benefits

- Scald prevention shower valve
- Easy to remove shower seat when not required
- Stylish chrome grab rails
- Modern and contemporary style



Click the button to view these pack contents online

See page 91 for typical layouts

Concept Freedom Doc M Shower Pack
S6407AA



Ideal Standard



Ideal Standard Concept Freedom Doc M Shower Pack is ideal for the more luxurious, wheelchair accessible shower room with everything required delivered in one box.

Features & Benefits

- Easy turn shower and shower kit handles
- Thermostatic shower valve
- Luxury Hewi shower seat and chrome grab rails



Click the button to view these pack contents online

See page 91 for typical layouts

WC Doc M Pack with exposed cistern

HD - Possible position for automatic hand dryer
SD - Soap dispenser
PT - Paper towel dispenser
AR - Alarm reset button
TP - Toilet paper dispenser

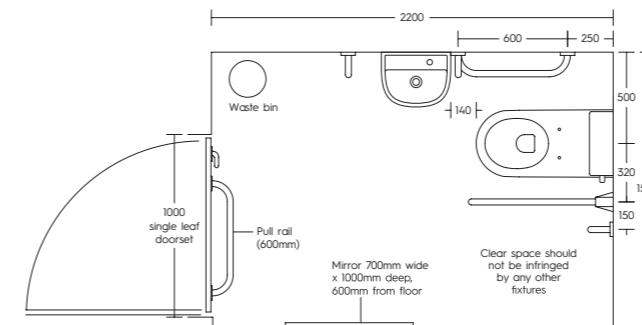
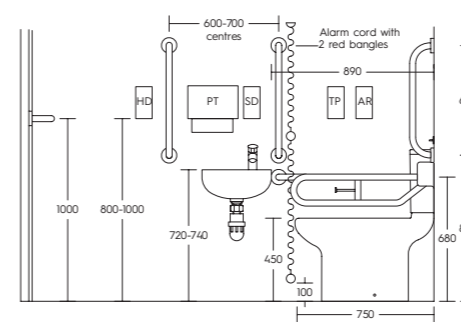

WC Doc M Pack with concealed cistern

HD - Possible position for automatic hand dryer
SD - Soap dispenser
PT - Paper towel dispenser
AR - Alarm reset button
TP - Toilet paper dispenser

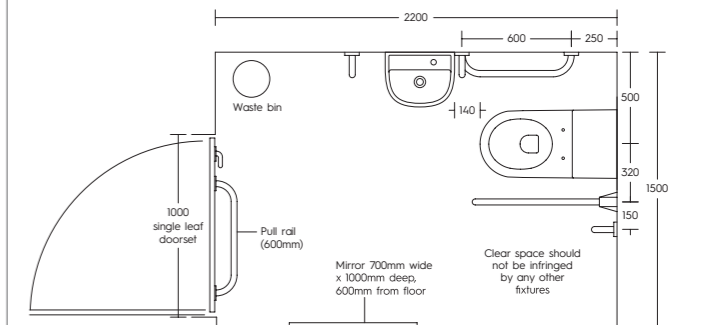
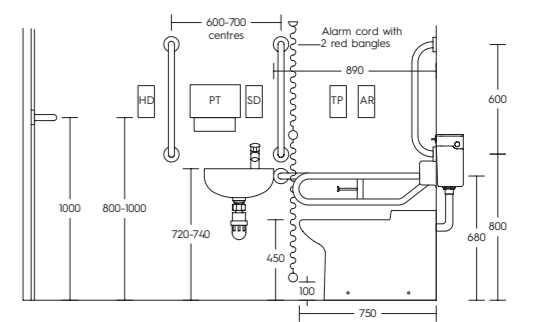

Peninsular Care Pack with large basin

SD - Soap dispenser
PT - Paper towel dispenser

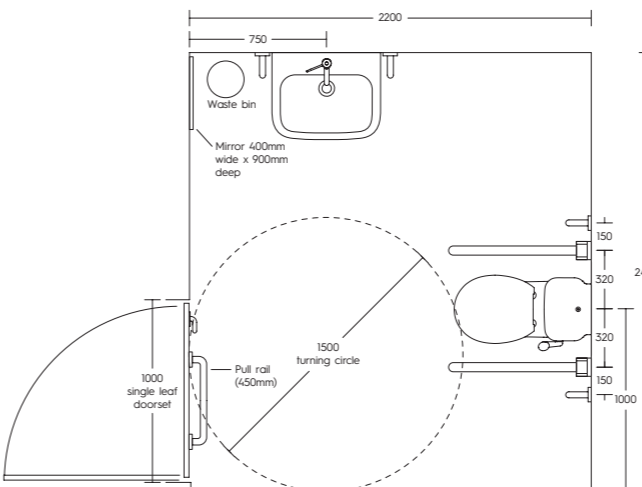
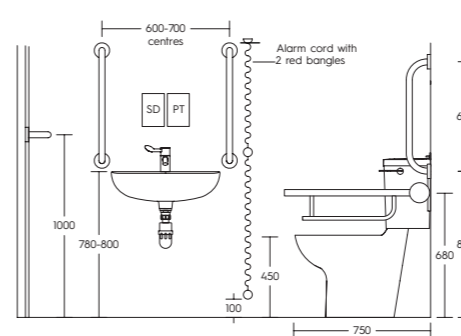

Shower Doc M Pack

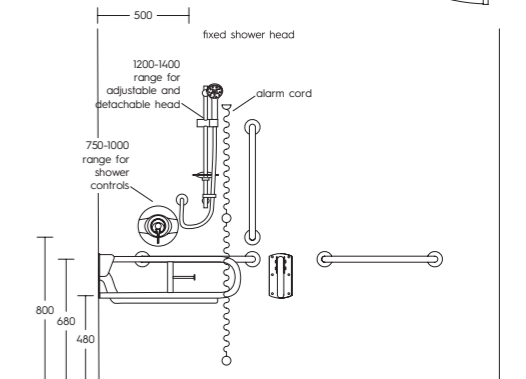
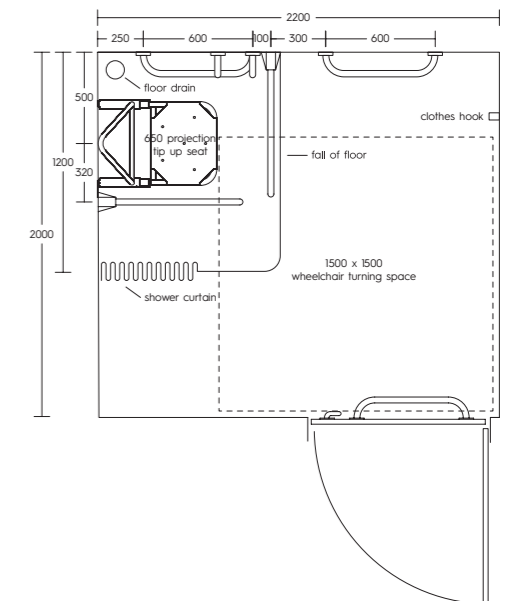

450mm Straight Powder Coated Grab Rails – Exposed Fixing GRAB101

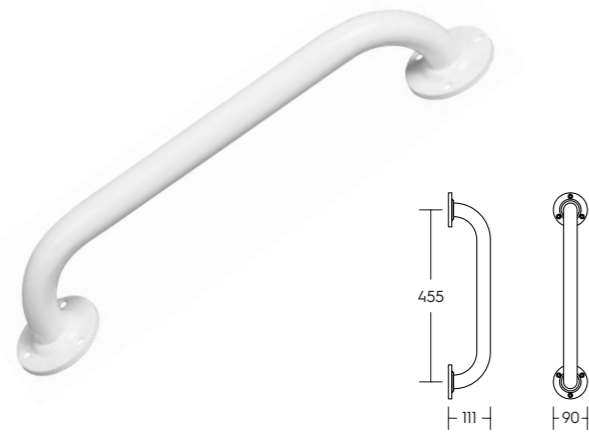

SanCeram

Features & Benefits

- Powder coated
- Exposed fixing
- Suitable for dry environments

Size

- 450mm x Ø35mm

Material

- Mild steel

Product Options

- White (RAL 9016): GRAB101
- Blue (RAL 5011): GRAB104
- Light grey (RAL 7005): GRAB107
- Dark grey (RAL 7016): GRAB110



455mm Straight Powder Coated Stainless Steel Grab Rails – Concealed Fixing GRAB201

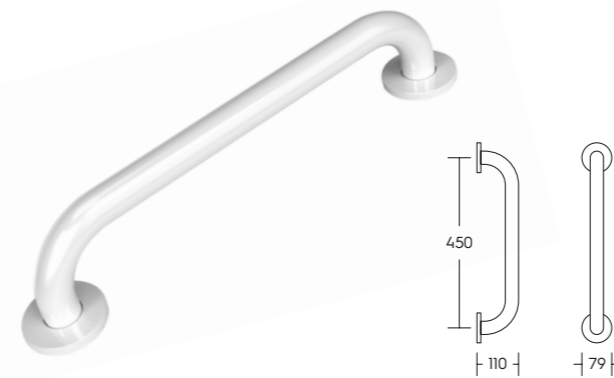

SanCeram

Features & Benefits

- Powder coated
- Concealed fixing
- Suitable for wet or dry environments

Size

- 455mm x Ø35mm

Material

- Stainless steel

Product Options

- White (RAL 9016): GRAB201
- Blue (RAL 5011): GRAB204
- Light grey (RAL 7005): GRAB207
- Dark grey (RAL 7016): GRAB210



600mm Straight Powder Coated Grab Rails – Exposed Fixing GRAB102

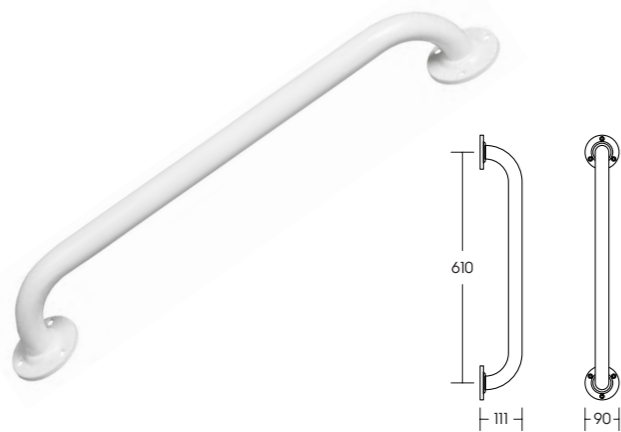

SanCeram

Features & Benefits

- Powder coated
- Exposed fixing
- Suitable for dry environments

Size

- 600mm x Ø35mm

Material

- Mild steel

Product Options

- White (RAL 9016): GRAB102
- Blue (RAL 5011): GRAB105
- Light grey (RAL 7005): GRAB108
- Dark grey (RAL 7016): GRAB111



600mm Straight Powder Coated Stainless Steel Grab Rails – Concealed Fixing GRAB202

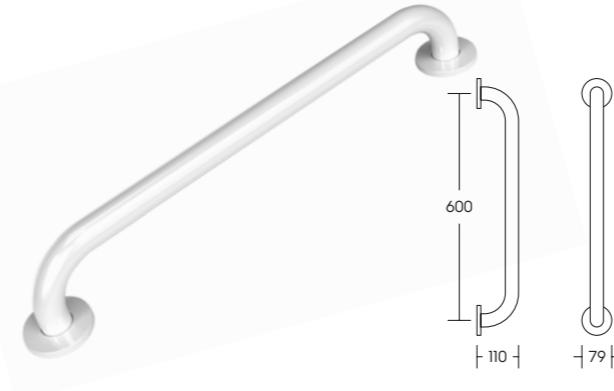

SanCeram

Features & Benefits

- Powder coated
- Concealed fixing
- Suitable for wet or dry environments

Size

- 600mm x Ø35mm

Material

- Stainless steel

Product Options

- White (RAL 9016): GRAB202
- Blue (RAL 5011): GRAB205
- Light grey (RAL 7005): GRAB208
- Dark grey (RAL 7016): GRAB211



800mm Hinged Powder Coated Grab Rails – Exposed Fixing GRAB103

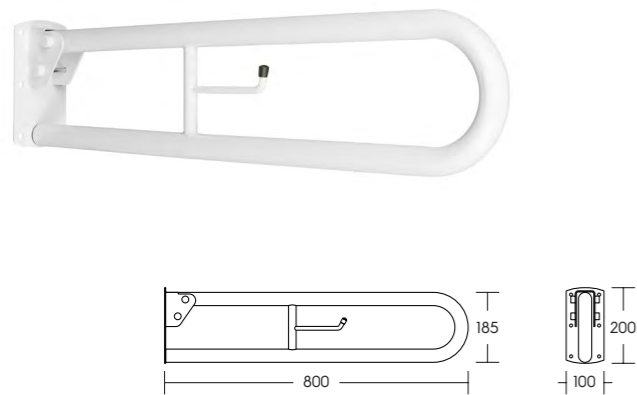

SanCeram

Features & Benefits

- Powder coated
- Exposed fixing
- Toilet roll holder included
- Lift and lock operation
- Suitable for dry environments

Size

- 800mm x Ø35mm

Material

- Mild steel

Product Options

- White (RAL 9016): GRAB103
- Blue (RAL 5011): GRAB106
- Light grey (RAL 7005): GRAB109
- Dark grey (RAL 7016): GRAB112



800mm Hinged Powder Coated Stainless Steel Grab Rails – Concealed Fixing GRAB203

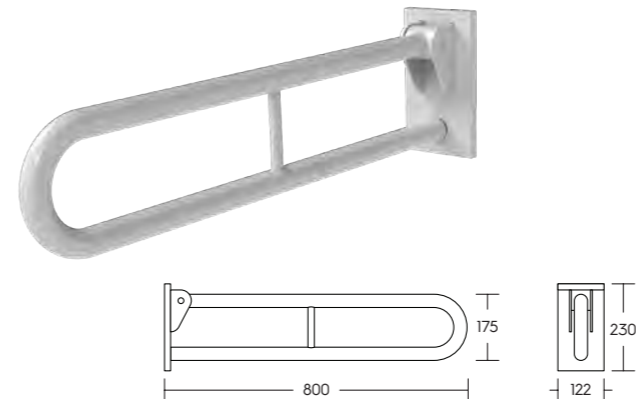

SanCeram

Features & Benefits

- Powder coated
- Concealed back plate
- Friction folding mechanism
- No toilet roll holder
- Suitable for wet or dry environments

Size

- 800mm x Ø35mm

Material

- Stainless steel

Product Options

- White (RAL 9016): GRAB203
- Blue (RAL 5011): GRAB206
- Light grey (RAL 7005): GRAB209
- Dark grey (RAL 7016): GRAB212



Contemporary Chrome Grab Rails GRAB122

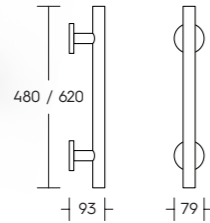

SanCeram

- Features & Benefits**
- Polished chrome finish
 - Concealed fixing
 - Suitable for wet or dry environments

Size
• Ø35mm

Material
• Stainless steel

- Product Options**
- 480mm contemporary chrome grab rail – GRAB122
 - 620mm contemporary chrome grab rail – GRAB123



800mm Hinged Stainless Steel Grab Rails GRAB115

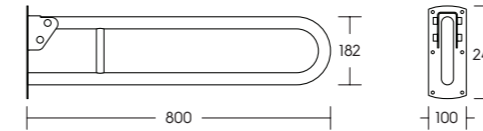

SanCeram

- Features & Benefits**
- Polished finish
 - Exposed fixing
 - No toilet roll holder
 - Lift and lock operation
 - Suitable for wet or dry environments

Size
• 800mm x Ø32mm

Material
• Stainless steel



Contemporary Chrome Drop Down Grab Rails GRAB124

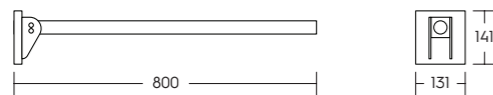

SanCeram

- Features & Benefits**
- Polished chrome finish
 - Concealed fixing plate
 - Friction folding mechanism
 - Suitable for wet or dry environments

Size
• 800mm x Ø35mm

Material
• Stainless steel



WC Back Rest GRBR101

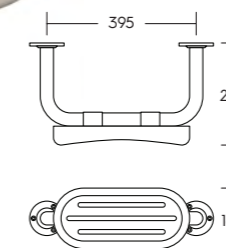

SanCeram

- Features & Benefits**
- Exposed fittings
 - For use with 750mm projection WCs
 - Suitable for dry environments

Size
• 400mm x 270mm

Material
• Mild steel

- Product Options**
- WC back rest white – GRBR101
 - WC back rest blue – GRBR102
 - WC back rest grey – GRBR103



Stainless Steel Grab Rails in Polished Finish GRAB113

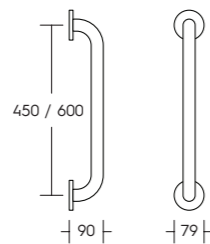

SanCeram

- Features & Benefits**
- Polished finish
 - Concealed fixing
 - Suitable for wet or dry environments

Size
• Ø32mm

Material
• Stainless steel

- Product Options**
- 450mm stainless steel grab rail in polished finish – GRAB113
 - 600mm stainless steel grab rail in polished finish – GRAB114



Specifying sanitaryware for healthcare environments can be a real challenge due to the number of factors you are required to consider. You can be confident that with our SanCeram and other market leading dedicated healthcare ranges, that hygiene and infection control are top of the agenda with all HBN requirements being met.

The regulations that have a bearing on healthcare sanitaryware are HBN 00-10 part C for England and SHTM64 in Scotland, this covers guidelines for sanitaryware assemblies in healthcare environments. Taking into account area of use, infection control, ease of maintenance, health & safety and efficiency.

As well as Brassware, Basins and WCs, we also have a range of Showers, Grab Rails and Urinals, all suitable for clinical installations. So you can be assured that we have taken into account your demand for maximum hygiene and quality, whilst ensuring the products remain aesthetically pleasing.

Brassware

Our dedicated healthcare Brassware range includes the renowned Armitage Shanks Markwik 21 Healthcare Tap as well as our SanCeram option, both offering a long paddle lever for ease of use or sensor versions for complete no touch operation. Features to look out for within our Brassware collection include Anti-scald, WRAS and TMV3 approvals.

Basins

Our comprehensive range of healthcare Basins have been designed with water efficiency, maximum hygiene, quality and aesthetics in mind. Our healthcare and clinical basins are all HBN compliant, we also have special care basins for non-clinical areas of healthcare projects.

WCs

With extended projection and a high performing rimless flush design, our range of special care toilets ensure your toilet pan will perform as you expect it to. Upon request we can provide regulators specification testing results to show efficient and hygienic flushing performance of SanCeram pans when paired with our range of Tyde cisterns.

Icon key – Features of our products

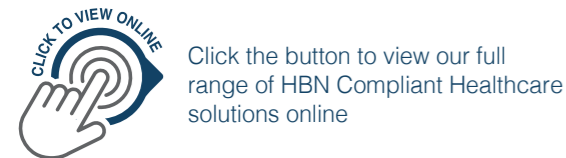

Click the button to view our full range of HBN Compliant Healthcare solutions online



With a wide selection of products suitable for healthcare as well as other applications, be sure to look out for our HBN compliant products in other sections of the brochure with this icon.

There are numerous ways to minimise the risk of acquiring infections in hospitals and healthcare environments. By using our Healthcare Brassware range you can be assured that all of your HBN and SHTM obligations are met.

- ✓ Our SanCeram Healthcare TMV3 Wall Mounted Lever and Sensor Taps, both with Removable Spouts and the SanCeram Sequential TMV3 Mixer Tap are ideal to help control Legionella (HTM 04-01). With built in TMV values, the time water is at a lower temperature (when bacteria can multiply) is kept to a minimum
- ✓ These taps also have self-draining spouts, so any unused water is dispersed into the basin and not stored in the spout until the next use
- ✓ They also offer easy operation, so they can be turned on and off without contaminating hands e.g. sensor for no-touch or long levers for elbow operation



We recommend...

The Armitage Shanks Markwik 21+ Healthcare Lever Tap with Chartham Wall Hung 500mm Clinical Back Outlet Basin.

The KWC DVS Stainless Steel Surgeon's Scrub Trough is available in both left and right handing.

Our Chartham Rimless Back to Wall 700 Projection Toilet Pan for wheelchair accessible Healthcare settings.

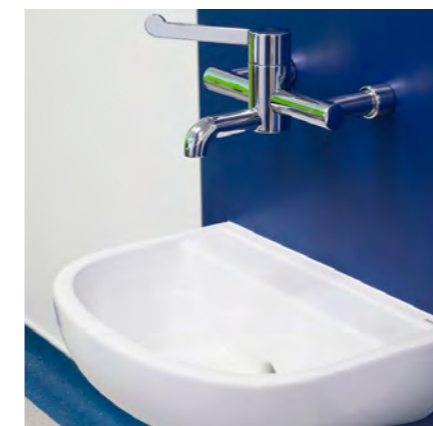

Installed at: Acre Mills Hospital

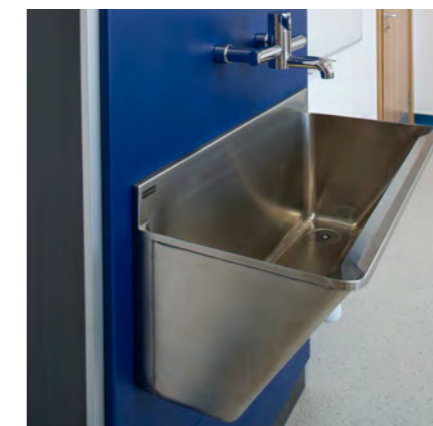

Installed at: Acre Mills Hospital



Installed at: Nelson Hospital

Disposal Unit DU G22041N



- Essential Items**
- 9ltr concealed cistern – F3018
 - Chain pull for flush – F2055
 - Flush pipe – B3022
 - Stainless steel waste – F2068
 - Plastic P trap – B4042
 - Cantilever brackets left – G26523L
 - Cantilever brackets right – G26523R

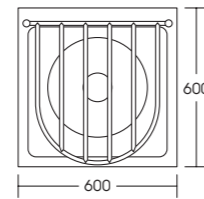

Disposal Unit DU H G22016L/R



- Essential Items**
- 9ltr concealed cistern – F3018
 - Chain pull for flush – F2055
 - Flush pipe – B3022
 - Plastic P trap – B4042
 - Stainless steel removable outlet grating – G26542N
 - Cantilever bracket left – G26523L
 - Cantilever bracket right – G26523R

CODE	DRAINER HANDING
G22016L	Left
G22016R	Right

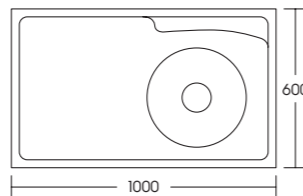

Disposal Unit DU HS G22018L/R



- Essential Items**
- 9ltr concealed cistern – F3018
 - Chain pull for flush – F2055
 - Flush pipe – B3022
 - Stainless steel waste – F2068
 - Plastic P trap – B4042
 - Stainless steel removable outlet grating – G26542N
 - Cantilever bracket left – G26523L
 - Cantilever bracket right – G26523R

CODE	DRAINER HANDING
G22018L	Left
G22018R	Right

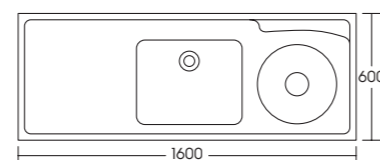

Plaster Sink PS H G22000L/R



- Essential Items**
- Stainless steel waste – F2068
 - 1½" plastic bottle trap – C10R
 - Cantilever bracket left – G26523L
 - Cantilever bracket right – G26523R

CODE	DRAINER HANDING
G22000LN	Left
G22000RN	Right

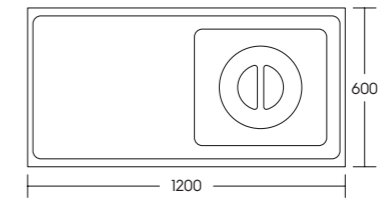

Janitorial Unit JU G20055N



- Essential Items**
- Combination waste kit – G20051N
 - 1½" plastic bottle trap – C10R
 - 1¼" plastic bottle trap – A10R

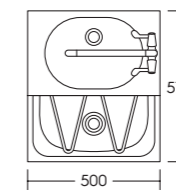

Surgeon's Scrub Troughs SU H1 G22029LN/RN



- Essential Items**
- Waste outlet and shroud included
 - 1½" plastic bottle trap – C10R

CODE	LENGTH (A)	WASTE HANDING
G22029LN	800mm	Left
G22029RN	800mm	Right
G22030LN	1600mm	Left
G22030RN	1600mm	Right
G22031LN	2400mm	Left
G22031RN	2400mm	Right

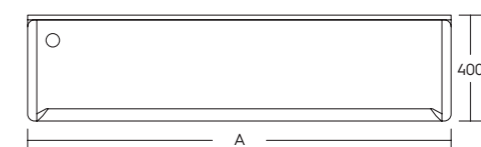

Sink and Drainer ST A G22006L/R



Essential Items

- Stainless steel waste – F2068
- 1½" plastic bottle trap – C10R
- Cantilever bracket left – G26523L
- Cantilever bracket right – G26523R

CODE	DRAINER HANDING
G22006L	Left
G22006R	Right

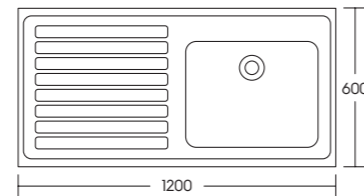

Sink and Double Drainer ST B G22008D



Essential Items

- Stainless steel waste – F2068
- 1½" plastic bottle trap – C10R
- Cantilever bracket left – G26523L
- Cantilever bracket right – G26523R

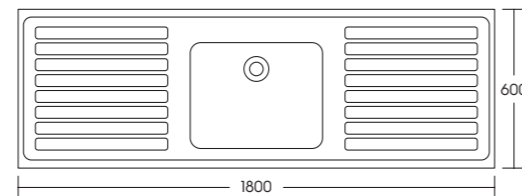

Double Sink and Drainer ST C G22010L/R



Essential Items

- Stainless steel waste – F2068 (2no)
- 1½" plastic bottle trap – C10R (2no)
- Cantilever bracket left – G26523L
- Cantilever bracket right – G26523R

CODE	DRAINER HANDING
G22010L	Left
G22010R	Right

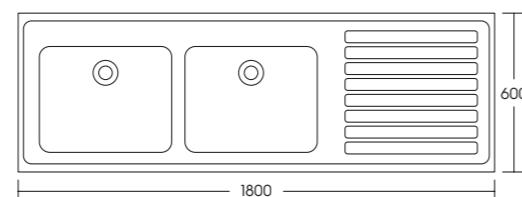

Single Bowl Sink SK 1 G22002N



Essential Items

- Stainless steel waste – F2068
- 1½" plastic bottle trap – C10R
- Cantilever bracket left – G26523L
- Cantilever bracket right – G26523R

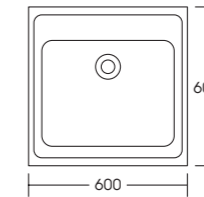

Double Bowl Sink SK 2 G22004N



Essential Items

- Stainless steel waste – F2068 (2no)
- 1½" plastic bottle trap – C10R (2no)
- Cantilever bracket left – G26523L
- Cantilever bracket right – G26523R

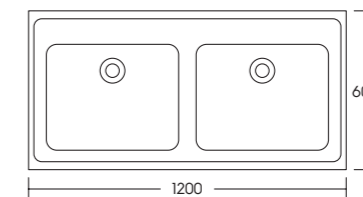

Chartham Wall Hung 500 Clinical Back Outlet Basin CHWB107



Our SanCerem Chartham 500mm Wall Hung Clinical Back Outlet Basin with no tap holes is both HBN and SHTM compliant, so you can install it in your clinical environment with confidence.

A full listing can be seen on page 51.

Chartham Wall Hung 380 Basin LHTH CHWB101



Our compact SanCerem Chartham 380mm Wall Hung Basin with a left hand tap hole is ideal for use where space is at a premium and is both Doc M and HBN compliant.

A full listing can be seen on page 50.

Chartham Wall Hung 500 Basin RHTH CHWB105



Our SanCerem Chartham 500mm Wall Hung Basin with right handed tap hole is ideal to make your washroom feel more spacious with the added benefit of being both HBN and Doc M compliant.

A full listing can be seen on page 50.

Contour 21+ 50cm Back Outlet Washbasin S0430HY



Armitage Shanks Contour 21+ 500mm Back Outlet Washbasin, ideal for use in healthcare environments and is HBN and SHTM compliant.

A full listing can be seen on page 51.

SanCerem Healthcare TMV3 Wall Mounted Lever Tap – Removable Spout SCBW122



Our SanCerem Healthcare TMV3 Wall Mounted Lever Tap with Removable Spout is HBN and SHTM compliant and has a long paddle lever and a full safe touch body.

A full listing can be seen on page 76.

SanCerem Healthcare TMV3 Wall Mounted Sensor Tap – Removable Spout SCBW123



Our SanCerem Healthcare TMV3 Wall Mounted Sensor Tap with Removable Spout is HBN and SHTM compliant so can be used in clinical areas with confidence.

A full listing can be seen on page 76.

Markwik 21+ Panel Mounted Thermostatic Basin Mixer Tap A6682AA



Armitage Shanks Markwik 21+ Panel Mounted Thermostatic Basin Mixer Tap, has a single sequential lever for easy operation and is both HBN and SHTM compliant.

A full listing can be seen on page 76.

Markwik 21+ Panel Mounted Thermostatic Basin Mixer Tap, with Time Flow Sensor A6737AA



Armitage Shanks Markwik 21+ Panel Mounted Thermostatic Basin Mixer Tap, with time flow sensor and fixed spout complies with all HBN and SHTM requirements.

A full listing can be seen on page 77.

SanCeram Sequential TMV3 Mixer Tap
SCBW120



Our SanCeram Sequential TMV3 Mixer Tap offers easy operation and is ideal for healthcare environments being HBN and SHTM compliant when installed with copper tails.

A full listing can be seen on page 66.

SanCeram Deck Mounted Sensor Tap
SCBW119



Our SanCeram Deck Mounted Sensor Tap for pre mixed water is DDA compliant and delivers water without touch, perfect for washrooms where hygiene and water economy are key factors.

A full listing can be seen on page 71.

Marden Concealed Trap Urinal Bowl with Fixings
MDUR101



Our SanCeram Marden Concealed Trap Urinal Bowl with Fixings is for use with a back inlet spreader and concealed cistern feed and is HBN and SHTM compliant.

A full listing can be seen on page 41.

Contour Urinal Bowl
S611001



Armitage Shanks Contour Urinal Bowl has a concealed trap for a clean, modern finish and is HBN and SHTM compliant.

A full listing can be seen on page 42.

Chartham Rimless Back to Wall 700 Projection Toilet Pan
CHWC105



Our SanCeram Chartham Rimless Back to Wall Toilet Pan has extended projection to 700mm for HBN and SHTM compliance.

A full listing can be seen on page 23.

Chartham Wall Hung 700 Projection Toilet Pan
CHWC117



Our SanCeram Chartham Wall Hung 700mm Projection Toilet Pan is ideal for healthcare environments and is HBN and SHTM compliant.

A full listing can be seen on page 24.

Contour 21+ Rimless 700mm Back to Wall Toilet Pan
S0437HY



Armitage Shanks Contour 21+ Rimless 700mm projection Back to Wall Toilet Pan with horizontal outlet for HBN and SHTM compatibility.

A full listing can be seen on page 24.

Contour 21 Wall Hung 700mm Projection Toilet Pan
S307701



Armitage Shanks Contour 21 Wall Hung 700mm Projection Toilet Pan with horizontal outlet and 700mm extended projection offers HBN and SHTM compliance for healthcare installations.

A full listing can be seen on page 25.

Our Shower range includes Concealed and Exposed installation options for Shower Valves and Shower Packs. Also in the range are Kits, Rails, Heads, Trays and Enclosures. We have solutions for every environment including leisure, education, healthcare, commercial and residential.

Our range includes options that are both HBN and DDA compliant, as well as TMV and WRAS approved. With water saving features along with built in safety stop features, you can ensure your shower area is safe, compliant and environmentally friendly.

Shower Packs and Shower Kits

With the options of Concealed and Exposed Shower Valves, our complete Shower Packs contain everything needed for your shower requirements. We have features such as built in fail safe anti-scald protection and WRAS approval. Many offer quick, easy fit and forget solutions that are stylish, affordable and compliant. Our Shower Kits include packs that are TMV2 or TMV3 approved, Doc M and HBN compliant depending on your needs. With features such as water saving Eco buttons and WRAS approval, we have Shower Kits to suit your every requirement.

Shower Valves

Depending on your installation needs we offer Concealed or Exposed Shower Valves, along with options which are Doc M and HBN compliant. Suitable for a wide variety of applications, we have options with pre-set temperature hot stops to prevent scalding and water saving features for WRAS approval and BREEAM credits.

Shower Heads

Our range of Shower Heads cover everything from Anti-ligature options to contemporary and modern designs. Features to look out for include easy DIY installation and WRAS approval.

Show Trays and Enclosures

Our selection of Shower Trays and Enclosures from SanCeram and Merlyn will complete any shower area whether it be for commercial, leisure or domestic use. Available in various styles and sizes, with features including toughened glass and Aquaglean for easy cleaning, our Shower Enclosures offer style as well as substance.



Icon key – Features of our products

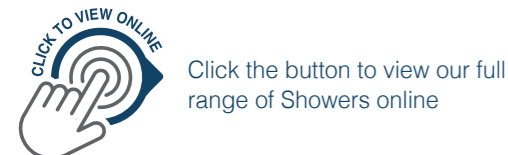

The Slip Resistant Pendulum Test
Preferred assessment method of the Health & Safety Executive

Test method subject of British Standard BS 7976: Parts 1-3, 2002.2

Barefoot Wet Condition Test
The tester swings an imitation heel (using a standardised rubber soling sample) over a set area in a controlled manner.

MERLYN reached an SRV (Slip Resistance Value) in wet conditions greater than the required 36 mark. This ranks MERYLN in a premium class.

For school changing rooms and leisure facilities, the Inta I-Sport Compact Shower Panel is the ideal solution.

Designed for high use washrooms, the timed flow control automatically closes off the water ensuring it is not left running, saving water and safeguarding against accidental flooding. The shower panel's sleek and durable design will perform reliably time after time.

- ✓ All-in-one compact, lightweight design
- ✓ Top or back inlet connection
- ✓ 8 litres per minute flow regulator
- ✓ Directional control of the shower head
- ✓ Pneumatic time flow control
- ✓ Anti limescale rub-clean head
- ✓ WRAS approved



We recommend...

Leisure

The winner of a Red Dot award in 2017, the Methven Aio Shower Handset with Aurajet technology delivers a full-bodied spray with maximum body contact and all-over warmth.



Methven Aio Shower Handset

Domestic

The Deva Vision Cool Touch Bar Shower with Diverter to Fixed Head & Handset offers a stylish, easy to use shower solution with the added benefit of WRAS approval.

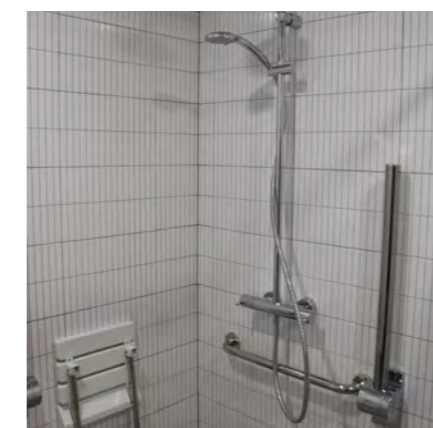

Installed at: Richmond Magistrates Court

Best all-rounder

SanCeram Sequential Lever Operated Concealed Shower Valve has a built in TMV3 cartridge to regulate water temperature and avoid scalding. It also has the benefits of being HBN, TMV3 and WRAS approved.



SanCeram Sequential Lever Operated Concealed Shower Valve

Thermostatic Bar Shower Pack
SHWR111



SanCeram



Our SanCeram Thermostatic Bar Shower Pack contains everything needed including; bar shower valve, headset, hose and rail, with the added bonus of being TMV2 and WRAS approved.

Features & Benefits

- Safe cool to touch body
- 38°C temperature hot stop with override facility
- Includes patented Satinjet handset
- Supplied with 9ltr flow regulator
- 1.5m easy clean hose
- 150mm inlet centres
- Adjustable brackets on riser kit – ideal for refurbishments

Finish

- Chrome

Operating Pressure

- Max: 5.0 bar
- Min: 0.3 bar

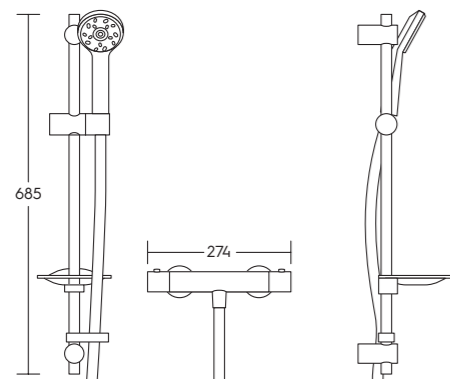

Alto EV Exposed Shower Pack
A5985AA



Armitage Shanks



Armitage Shanks Alto EV Exposed Shower Pack offers a modern and practical shower washroom solution with a safe cool to touch body.

Features & Benefits

- Safe cool touch body
- TMV2 approved
- Ceramic cartridge for accurate control and drip free use
- Includes single mode handset
- Shower hose retainer
- Innovative fast fix installation bracket

Finish

- Chrome

Operating Pressure

- Max: 5.0 bar
- Min: 0.1 bar

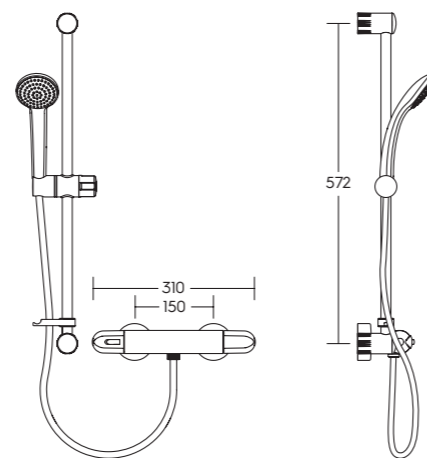

Vision Cool Touch Bar Shower with Diverter to Fixed Head & Handset
VCTSDEF



Deva by METHVEN



Deva Vision Cool Touch Bar Shower with Diverter to Fixed Head & Handset offers a stylish, easy to use shower solution.

Features & Benefits

- Safe cool to touch body
- 38°C temperature hot stop with override facility
- TMV2 approved
- Separate temperature and flow control
- Riser swivels 180° allowing you to select an optimal position
- Integral diverter to fixed head or handset
- Single mode shower head with swivel joint
- Double interlocked 1.5m hose
- 150mm inlet centres
- Riser height can be adjusted to suit (90mm - 110cm)

Finish

- Chrome

Operating Pressure

- Max: 5.0 bar
- Min: 1.5 bar

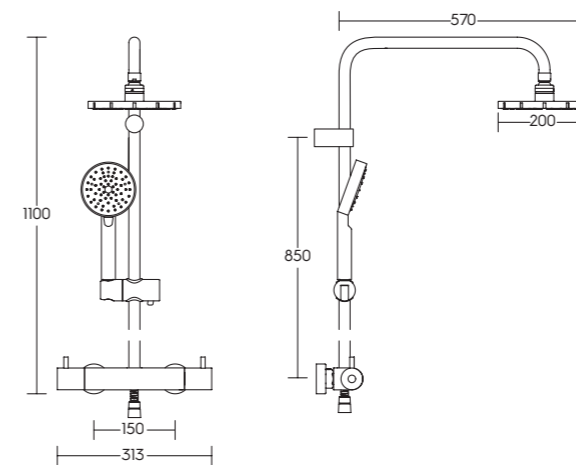

Trade-Tec Bar Shower with Kit
TR10032CP



inta



Inta Trade-Tec Bar Shower Kit offers thermostatic control with built in fail safe anti-scold protection delivering exceptional performance and safety.

Features & Benefits

- Anti-scald fail safe technology
- Sure-safe maximum temperature limit
- 150mm inlet centres
- Adjustable fixing points for riser
- Fast fix brackets for quick installation

Finish

- Chrome

Operating Pressure

- Max: 5.0 bar
- Min: 0.2 bar

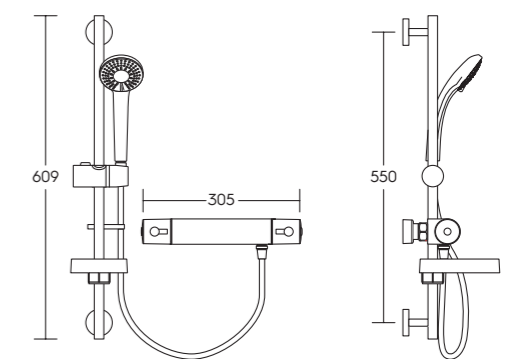

Trade-Tec Concealed Shower Kit
TR40014CP

inta



Inta Trade-Tec Concealed Shower Kit offers thermostatic control with built in, fail safe, anti-scold protection delivering exceptional performance and safety.

Features & Benefits

- Thermostatic control
- Anti-scald fail safe technology
- Sure-safe maximum temperature limit
- Adjustable fixing points for riser
- Concealed installation with 15mm direct compression connection

Finish

- Chrome

Operating Pressure

- Max: 5.0 bar
- Min: 0.2 bar

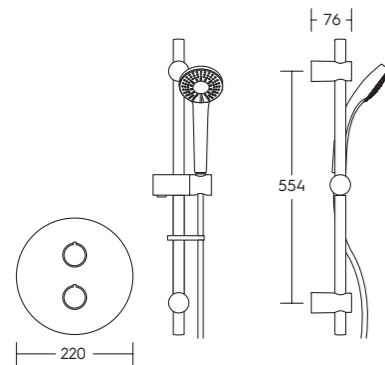

Trade-Tec Optimo Cool Thermostatic Bar Shower with Kit
TR20017CP

inta



Inta Trade-Tec Optimo Cool Thermostatic Bar Shower with Kit with cool touch body keeps the surface temperature from getting hot during use and is WRAS approved.

Features & Benefits

- Thermostatic TMV2 approved control
- Safe touch body
- Anti-scald fail safe technology
- Multi-function handset
- 150mm inlet centres
- Adjustable fixing points for riser
- Fast fix brackets for quick installation

Finish

- Chrome

Operating Pressure

- Max: 5.0 bar
- Min: 0.2 bar

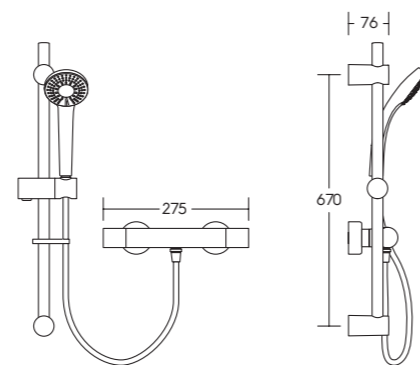

Trade Tec Thermostatic Bath Shower Mixer
TR30024CP

inta



Inta Trade Tec Thermostatic Bath Shower Mixer has thermostatic TMV2 approved control and is also WRAS approved.

Features & Benefits

- Thermostatic TMV2 approved control
- Anti-scald fail safe technology
- Sure-safe minimum temperature limit
- 180mm inlet centres
- Adjustable fixing points for riser
- Deck mounting legs

Finish

- Chrome

Operating Pressure

- Max: 5.0 bar
- Min: 0.2 bar

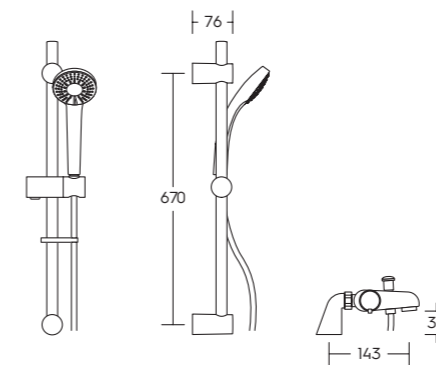

I-Sport Compact Shower Panel (Top Inlet)
SP9206CP

inta



Inta I-Sport Compact Shower Panel has been designed for high use washrooms with an adjustable spray direction, anti-limescale shower head and pneumatic time flow control.

Features & Benefits

- All-in-one compact design
- 8ltr per minute flow regulator
- 30 second flow time (+5/-10) at 3 bar pressure
- Top inlet connection
- Push button timed flow control and fixed shower head
- Directional control shower head
- Anti-limescale rub-clean head

Finish

- Chrome

Operating Pressure

- Max: 5.0 bar
- Min: 1.0 bar

Product Options

- Inta I-Sport Shower Panel (Back Inlet) – SP9207CP

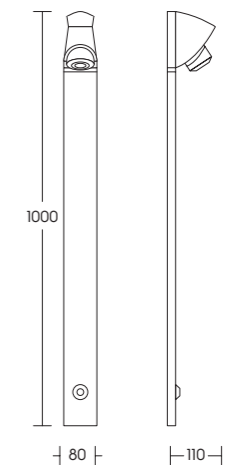

Armaglide 2 Shower Kit
B9306AA

Armitage Shanks



Armitage Shanks Armaglide 2 Shower Kit with single function hand spray, 900mm rail, 1750mm smooth hose and category 5 hose retainer.

Features & Benefits

- Single function shower hand set
- Includes 8ltr per minute flow regulator
- WRAS endorsed category 5 hose retainer
- Wall elbow
- Adjustable wall fixings
- Easy to install

Finish

- Chrome

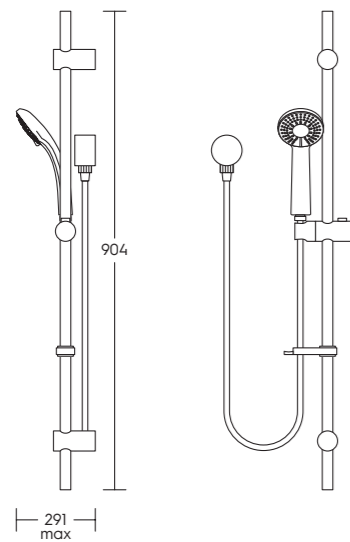

Substance Chrome Plated 3-function Kit
SIGKITM02

Deva by METHVEN



Deva Substance Chrome Plated 3-function Kit including 3 mode shower head, 1.5m hose and rail with soap dish.

Features & Benefits

- 3 mode handset
- Double interlocked 1.5m hose
- Adjustable brackets on riser kit – ideal for retrofit projects

Finish

- Chrome

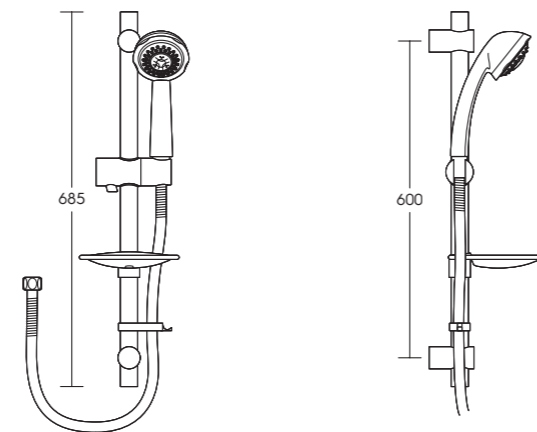

Grab Rail Based Shower Kit – White
SHWR115

SanCeram



Our SanCeram Grab Rail Based Shower Kit includes shower head and hose along with a white grab rail to be used as the shower rail.

Features & Benefits

- Multi-mode handset
- Easy to operate paddle lever
- Powder coated stainless steel grab rail, 900mm in white

Finish

- Chrome

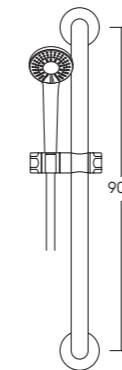

Easy Fit Shower Rail Kit
EFSR007

METHVEN



Methven Easy Fit Shower Rail Kit is a simple way to update your bathroom and ideal for refurbishments.

Features & Benefits

- Chrome rail with soap dish holder
- Button operation on slider adjustment
- Twist and lock brackets in place
- Adjustable brackets on riser kit – use any existing shower rail fixing holes

Finish

- Chrome

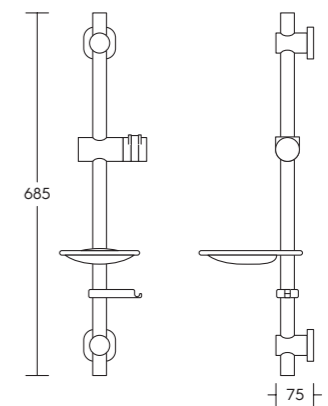

Sequential Lever Operated Concealed Shower Valve SHWR112

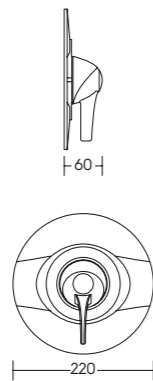

Features & Benefits

- Sequential lever operation for combined control of temperature and flow
- Factory set at 43°C to prevent scalding
- TMV3 approved
- Automatic safety shut off
- Supplied with 6ltr/min flow regulators
- Single piece thermal cartridge
- Concealed installation

Finish

- Chrome

Operating Pressure

- Max: 5.0 bar
- Min: 0.2 bar

Product Option

- Exposed version – SHWR113



SanCeram

Contour 21 Concealed Shower Valve A4129AA



Features & Benefits

- Sequential thermostatic lever operated
- TMV3 approved
- Automatic safety shut off
- Fail safe on hot and cold supplies
- Supplied with 5ltr/min flow regulators limiting max flow to 7.5ltr/min
- Extended easy to use lever
- Concealed installation

Finish

- Chrome

Operating Pressure

- Max: 5.0 bar
- Min: 0.5 bar

Product Option

- Exposed version – A4130AA



Armitage Shanks

Avon 21 Self-closing Concealed Shower Valve B8266AA

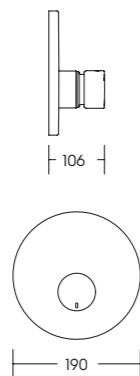

Features & Benefits

- Self-closing to help save water
- For pre-mixed water
- Top or bottom supply
- Concealed installation

Finish

- Chrome

Operating Pressure

- Max: 5.0 bar
- Min: 0.5 bar

Compatible Product

- TMV3 22mm temperature blending valve – SCBW114

Product Option

- Exposed version – B8264AA



Armitage Shanks

Self-closing Concealed Shower Valve SHWR122



Features & Benefits

- For pre-mixed water
- 15 seconds flow rate at 1 bar pressure
- Supplied with 6ltr/min flow regulator
- Concealed installation

Finish

- Chrome

Operating Pressure

- Max: 10.0 bar
- Min: 0.2 bar

Compatible Products

- TMV3 22mm temperature blending valve – SCBW114

Product Options

- Self-closing exposed shower valve – SHWR123



SanCeram

Vision Thermostatic Exposed Valve VSNVSEQT01

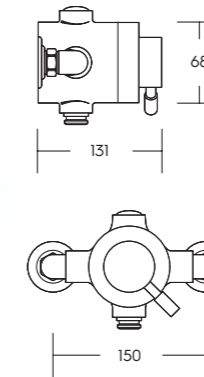

Features & Benefits

- TMV3 approved
- Easy to use lever operation
- Adjustable centres
- Suitable for all plumbing systems
- Exposed installation

Finish

- Chrome

Operating Pressure

- Max: 5.0 bar
- Min: 0.1 bar

Product Option

- Vision thermostatic concealed valve – VSNVSEQT02



Deva by METHVEN

Kaha Concealed Thermostatic Mixer Valve - 2 Outlet KAHA2D

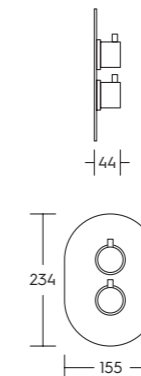

Features & Benefits

- TMV2 thermostatic approved
- 38°C temperature hot stop with override facility
- Diverter to two outlets
- Supplied with 7ltr/min flow regulators
- Front access to filters
- Brass concealing plate
- Concealed installation

Finish

- Chrome

Operating Pressure

- Max: 5.0 bar
- Min: 0.2 bar

Product Options

- Kaha concealed mixer valve for 2 outlets, ABS concealing plate – KAHA2DA



METHVEN

Kaha Concealed Thermostatic Mixer Valve KAHA1D

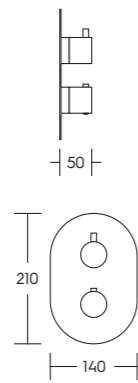

Features & Benefits

- TMV2 thermostatic approved
- 38°C temperature hot stop with override facility
- Front access to filters
- Brass concealing plate
- Concealed installation

Finish

- Chrome

Operating Pressure

- Max: 5.0 bar
- Min: 0.2 bar

Product Options

- Kaha concealed mixer valve for single outlet, ABS concealing plate – KAHA1DA



METHVEN

Aio Shower Handset AOHSCPUK

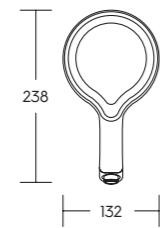

Features & Benefits

- Single mode handset
- Fitted with 9ltr min flow regulator
- Patented Aurajet technology
- Limescale resistant – hydrophobic properties resists the build-up of limescale
- Suitable for all plumbing systems
- Easy DIY installation

Finish

- Chrome

Operating Pressure

- Max: 5.0 bar
- Min: 1.0 bar



METHVEN

Kiri Low Flow Shower Handset SJK23-LF

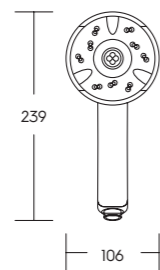

Features & Benefits

- Single function shower handset
- Supplied with a 5.7ltr/min flow regulator fitted
- Low-flow shower saves on water and money
- Patented Satinjet technology
- Modern design
- Easy DIY installation

Finish

- Chrome

Operating Pressure

- Max operating pressure: 5.0 bar
- Min operating pressure: 1.0 bar



METHVEN

Anti-ligature Fixed Shower Head SHWR118

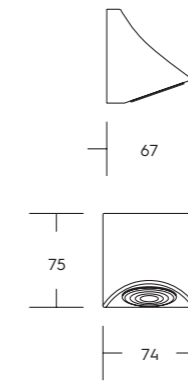

Features & Benefits

- Anti-ligature and vandal-resistant design
- Hidden wall fixing for security
- Unique head design
- Brass body
- Can be used as a shower head or basin spout for hand washing

Finish

- Chrome

Operating Pressure

- Max: 10.0 bar
- Min: 0.2 bar



SanCeram

200mm Circular Shower Head with Swivel SHWR121

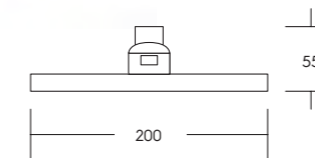

Features & Benefits

- 200mm round shower head
- Single function shower head
- Rub clean nozzles
- Adjustable head to angle spray

Finish

- Chrome

Operating Pressure

- Max: 5.0 bar
- Min: 0.1 bar

Compatible Extras

- SanCeram wall mounted shower arm – SHWR120



SanCeram

Anti-vandal Short Projection Shower Head SHWR124

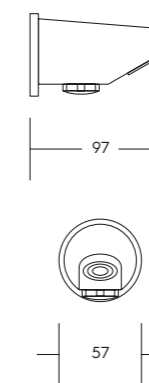

Features & Benefits

- Vandal resistant design
- Hidden wall fixing for security
- Brass body
- Spray pattern can be adjusted
- Suitable for all plumbing systems
- Concealed or exposed water connections

Finish

- Chrome

Operating Pressure

- Max: 10.0 bar
- Min: 0.2 bar



SanCeram

Standard 1.5m Shower Hose
HOS15CPS01



- Features & Benefits**
- ½" BSP inlet connections
 - Brass construction

- Finish**
- Chrome

- Product Options**
- Standard 2m shower hose – HOS20CPS03
 - Smooth 1.5m shower hose – HOS15PVS07



Outlet for Concealed Showers
SPE01



- Features & Benefits**
- Round style
 - 40mm thread length
 - Plastic trim plate
 - Brass construction

- Finish**
- Chrome



Wall Mounted Shower Arm
SHWR120



- Features & Benefits**
- Standard wall mounted arm
 - 295mm projection
 - Easy to install
 - Complete with ½" BSP connection

- Finish**
- Chrome

- Compatible Extras**
- SanCeram circular shower head – SHWR121



Square 45mm Shower Tray
STSQ457



SanCeram

Our SanCeram Square 45mm Shower Tray has a natural stone construction and is just 45mm high for a low step in.

- Features & Benefits**
- 45mm high for minimal step in
 - Ideal for in-floor wetroom look
 - Gel coating so the tray is not cold to the touch
 - Install in the floor or on the floor for flexibility
 - Easy DIY installation
 - Suitable for all plumbing systems
 - Waste and riser kits sold separately

- Material**
- Acrylic capped ABS stone resin

CODE	A	B	WASTE	RISER KIT
STSQ457	760	760	SHWT103	SHKIT45120
STSQ458	800	800	SHWT103	SHKIT45120
STSQ459	900	900	SHWT103	SHKIT45120

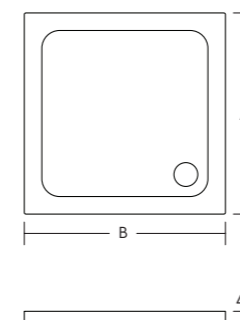

Touchstone Slip Resistant Square Shower Tray S80SQASTO



MERLYN

Merlyn Touchstone Slip Resistant Square Shower Tray has beautiful matt white finish and is manufactured to the highest standards to provide a safe showering space.

- Features & Benefits**
- 50mm high to achieve minimalist design
 - Anti-slip is manufactured into the coating and won't wear
 - Exceeds the requirements in two industry standards
 - Single skinned with moulded solid under section
 - 135mm high including riser kit
 - Waste and riser kits sold separately

- Material**
- Acrylic capped ABS stone resin

CODE	A	B	WASTE	RISER KIT
S80SQASTO	800	800	DWAS	DRK4
S90SQASTO	900	900	DWAS	DRK4

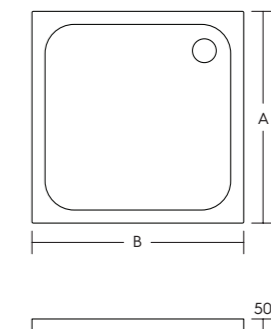

Rectangular 45mm Shower Tray
STRC45108



SanCeram

Our SanCeram rectangular 45mm, 1000mm x 800mm low profile shower tray has a natural stone construction.

Features & Benefits

- 45mm high for low step in
- Natural stone construction
- Gel coating so the tray is not cold to the touch
- Install in the floor or on the floor for flexibility
- Waste and riser kits sold separately

Material

- Acrylic capped ABS stone resin

CODE	A	B	WASTE	RISER KIT
STRC45108	1000	800	SHWT103	SHKIT45120
STRC45127	1200	760	SHWT103	SHKIT45120
STRC45128	1200	800	SHWT103	SHKIT45120
STRC45129	1200	900	SHWT103	SHKIT45120
STRC45148	1400	800	SHWT103	SHKIT45180
STRC45149	1400	900	SHWT103	SHKIT45180
STRC45177	1700	700	SHWT103	SHKIT45180
STRC45178	1700	800	SHWT103	SHKIT45180
STRC45179	1700	900	SHWT103	SHKIT45180

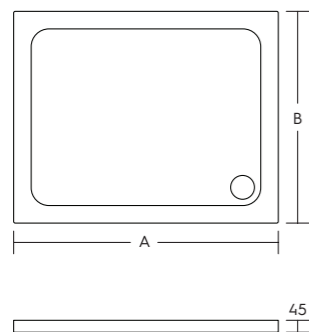

Touchstone Slip Resistant Rectangular Shower Tray S108RTASTO



MERLYN

Merlyn Touchstone Slip Resistant Rectangular Shower Tray, has anti-slip properties that are part of the acrylic capped ABS surface giving this shower tray excellent durability.

Features & Benefits

- 50mm high to achieve minimalist design
- Anti-slip is manufactured into the coating and won't wear
- Exceeds the requirements in two industry standards
- Single skinned with moulded solid under section
- 135mm high including riser kit
- Waste and riser kits sold separately

Material

- Acrylic capped ABS stone resin

CODE	A	B	WASTE	RISER KIT
S108RTASTO	1000	800	DWAS	DRK4
S109RTASTO	1000	900	DWAS	DRK4
S128RTASTO	1200	800	DWAS	DRK4
S129RTASTO	1200	900	DWAS	DRK4
S148RTASTO	1400	800	DWAS	DRK3
S149RTASTO	1400	900	DWAS	DRK3
S158RTASTO	1500	800	DWAS	DRK3
S159RTASTO	1500	900	DWAS	DRK3
S168RTASTO	1600	800	DWAS	DRK3
S169RTASTO	1600	900	DWAS	DRK3
S178RTASTO	1700	800	DWAS	DRK3
S179RTASTO	1700	900	DWAS	DRK3

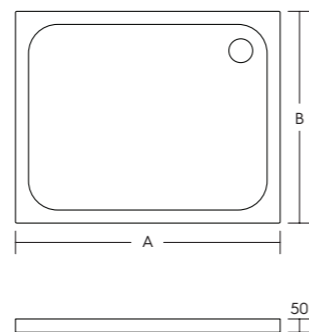

Quadrant 45mm Shower Tray
STQD45808



SanCeram

Our SanCeram Quadrant 45mm Shower Tray has a natural stone construction and is just 45mm high for low step in.

Features & Benefits

- Ideal for in-floor wetroom look
- Gel coating so the tray is not cold to the touch
- Install in the floor or on the floor for flexibility
- Waste and riser kits sold separately

Material

- Acrylic capped ABS stone resin

CODE	A	B	WASTE	RISER KIT
STQD45808	800	800	SHWT103	SHKITQ10
STQD45909	900	900	SHWT103	SHKITQ10
STQD45100	1000	1000	SHWT103	SHKITQ10

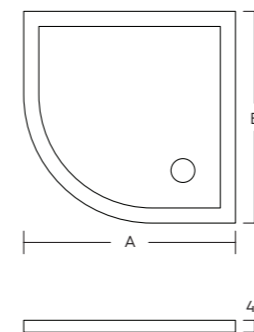

Touchstone Slip Resistant Quadrant Shower Tray S80QASTO



MERLYN

Merlyn Touchstone Slip Resistant Quadrant Shower Tray has a beautiful matt white finish, without the harsh surface texture sometimes experienced with an anti-slip finish.

Features & Benefits

- 50mm high to achieve minimalist design
- Anti-slip properties are part of the acrylic capped ABS surface and won't wear
- Exceeds the requirements in two industry standards
- Single skinned with moulded solid under section
- 135mm high including tray panel kit
- Waste and riser kits sold separately

Material

- Acrylic capped ABS stone resin

CODE	A	B	WASTE	RISER KIT
S80QASTO	800	800	DWAS	DRK2
S90QASTO	900	900	DWAS	DRK2

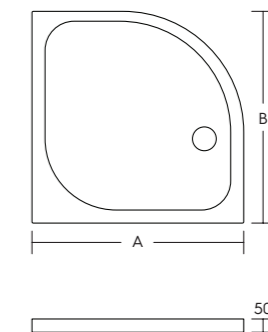

Offset 45mm Quadrant Shower Tray
STQL45108



SanCeram

Our SanCeram Offset 45mm Quadrant Shower Tray has a natural stone construction and is ideal to create a modern, in-floor wet room look.

Features & Benefits

- 45mm high
- Gel coating so the tray is not cold to the touch
- Install in the floor or on the floor for flexibility
- Waste and riser kits sold separately

Material

- Acrylic capped ABS stone resin

CODE	A	B	HANDING	WASTE	RISER KIT
STQL45108	1000	800	Left	SHWT103	SHKITQ10
STQL45128	1200	800	Left	SHWT103	SHKITQ12
STQL45129	1200	900	Left	SHWT103	SHKITQ12
STQR45108	1000	800	Right	SHWT103	SHKITQ10
STQR45128	1200	800	Right	SHWT103	SHKITQ12
STQR45129	1200	900	Right	SHWT103	SHKITQ12

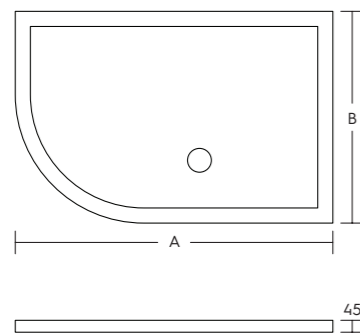

Touchstone Slip Resistant Offset Quadrant Rectangular Shower Tray
S108QLASTO



MERLYN

Merlyn Touchstone Slip Resistant Offset Quadrant Rectangular Shower Tray has beautiful matt white finish and anti-slip properties that are part of the acrylic capped ABS surface.

Features & Benefits

- 50mm high to achieve minimalist design
- Anti-slip is manufactured into the coating and won't wear
- Exceeds the requirements in two industry standards
- Single skinned with moulded solid under section
- 135mm high including tray panel kit
- Waste and riser kits sold separately

Material

- Acrylic capped ABS stone resin

CODE	A	B	HANDING	WASTE	RISER KIT
S108QLASTO	1000	800	Left	DWAS	DRK1
S128QLASTO	1200	800	Left	DWAS	DRK1
S129QLASTO	1200	900	Left	DWAS	DRK1
S108QRASTO	1000	800	Right	DWAS	DRK1
S128QRASTO	1200	800	Right	DWAS	DRK1
S129QRASTO	1200	900	Right	DWAS	DRK1

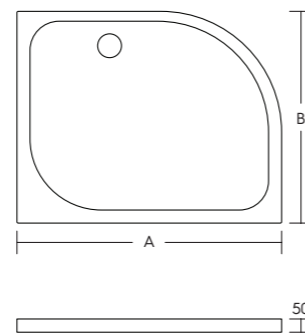

Mbox Corner Entry Shower Enclosure
MBC760



MERLYN

Merlyn MBox Corner Entry Shower Enclosure is manufactured from 6mm toughened glass and is reversible for left or right handed installation.

Features & Benefits

- 1900mm high
- Reversible
- Magnetic seals
- MerShield protected glass
- Chrome design handle
- 20mm adjustment at each wall junction

Finish

- Polished silver effect frame

Material

- 6mm clear toughened glass

CODE	SIZE (B)	ADJUSTMENT
MBC800	800 x 800mm	770 - 790mm
MBC900	900 x 900mm	870 - 890mm

CODE	ENTRY (A)	FIXED PANELS
MBC800	375mm	330mm
MBC900	444mm	380mm

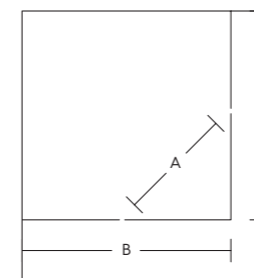

Quadrant Framed Shower Enclosure
SHQD800F



SanCeram

Our SanCeram 2 door Quadrant Framed Shower Enclosure is manufactured from 6mm toughened glass and has a framed design for maximum strength.

Features & Benefits

- 1900mm high
- Reversible
- Magnetic seals
- Aquaglean on glass for easy cleaning
- Chrome design handle
- Framed design for maximum strength
- 20mm adjustment at each wall junction

Finish

- Polished silver effect frame

Material

- 6mm clear toughened glass

CODE	SIZE (B)	ADJUSTMENT
SHQD800F	800 x 800mm	770 - 790mm
SHQD900F	900 x 900mm	870 - 890mm

CODE	ENTRY (A)	FIXED PANELS
SHQD800F	415mm	190mm
SHQD900F	534mm	290mm

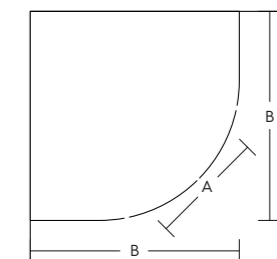

MBox 2 Door Quadrant Shower Enclosure MB2Q800



MERLYN™

Merlyn MBox 2 Door Quadrant Shower Enclosure, reversible for left or right-handed installation and manufactured from 6mm toughened glass.

Features & Benefits

- 1900mm high
- Reversible
- Magnetic seals
- MerShield protected glass
- Quick release double rollers for easy clean
- Easy fit frame
- 20mm adjustment per wall profile

Finish

- Chrome

Material

- 6mm clear toughened glass

CODE	SIZE (B)	ADJUSTMENT	ENTRY (A)
MB2Q800	800 x 800mm	770 - 790mm	422mm
MB2Q900	900 x 900mm	870 - 890mm	476mm

CODE	FIXED PANEL (C)	FIXED PANEL (D)
MB2Q800	490mm	235mm
MB2Q900	529mm	335mm

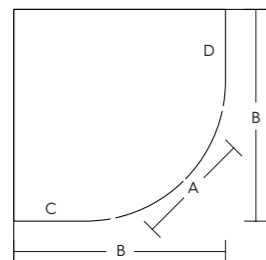

Offset Quadrant Framed Shower Enclosure SHQD128F



SanCeram

Our SanCeram Offset Quadrant Framed Shower Enclosure is manufactured from 6mm toughened glass and has Aquaglean on the glass for easy cleaning.

Features & Benefits

- 1900mm high
- Reversible
- Magnetic seals
- Chrome design handle
- Framed design for maximum strength
- 20mm adjustment at each wall junction

Finish

- Polished silver effect frame

Material

- 6mm clear toughened glass

CODE	SIZE (B)	SIZE (C)	ENTRY (A)
SHQD108F	1000mm	800mm	472mm
SHQD128F	1200mm	900mm	472mm

CODE	FIXED PANEL (D)	FIXED PANEL (E)
SHQD108F	190mm	390mm
SHQD128F	190mm	590mm

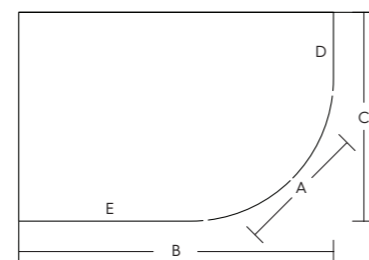

MBox 1 Door Offset Quadrant Shower Enclosure MB1Q1080



MERLYN™

Merlyn MBox 1 Door Offset Quadrant Shower Enclosure, manufactured from 6mm toughened glass with an easy fit frame.

Features & Benefits

- 1900mm high
- Reversible
- Magnetic seals
- Quick release double rollers for easy clean
- 20mm adjustment per wall profile

Finish

- Chrome

Material

- 6mm clear toughened glass

CODE	SIZE (B)	SIZE (C)	ENTRY (A)
MB1Q1080	1000mm	800mm	422mm
MB1Q1280	1200mm	800mm	424mm
MB1Q1290	1200mm	900mm	475mm

CODE	FIXED PANEL (D)	FIXED PANEL (E)
MB1Q1080	490mm	435mm
MB1Q1280	490mm	635mm
MB1Q1290	529mm	635mm

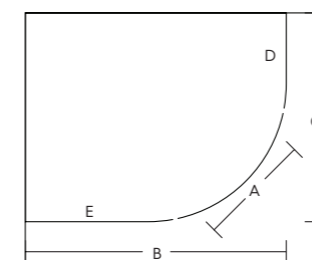

Pivot Framed Shower Door SHPV760F



SanCeram

Our SanCeram Pivot Framed Shower Door is manufactured from 6mm toughened glass and is reversible for left or right-handed installation.

Features & Benefits

- 1900mm high
- Reversible
- Magnetic seals
- Aquaglean on glass for easy cleaning
- Chrome design handle
- Framed design for maximum strength
- 20mm adjustment at each wall junction

Finish

- Polished silver effect frame

Material

- 6mm clear toughened glass

Compatible products

- SanCeram framed shower side panel 760mm – SHSID76F
- SanCeram framed shower side panel 800mm – SHSID80F
- SanCeram framed shower side panel 900mm – SHSID90F

CODE	SIZE	ADJUSTMENT (A)
SHVP760F	760mm	724 - 764mm
SHVP800F	800mm	764 - 804mm
SHVP900F	900mm	864 - 904mm

CODE	ENTRY	DOOR SWING (B)
SHVP760F	519mm	509mm
SHVP800F	555mm	549mm
SHVP900F	555mm	549mm

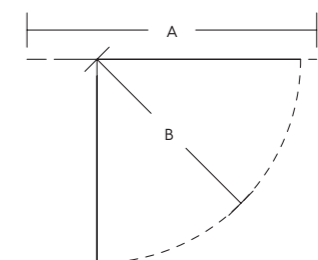

Bi-Fold Framed Shower Door
SHBIF76F



SanCeram

Our SanCeram Bi-fold Framed Shower Door is manufactured from 6mm toughened glass and has Aquaglean on the glass for easy cleaning.

Features & Benefits

- 1900mm high
- Reversible
- Magnetic seals
- Aquaglean on glass for easy cleaning
- Chrome design handle
- Framed design for maximum strength
- 20mm adjustment at each wall junction

Finish

- Polished silver effect frame

Material

- 6mm clear toughened glass

Compatible products

- SanCeram framed shower side panel 760mm – SHSID76F
- SanCeram framed shower side panel 800mm – SHSID80F
- SanCeram framed shower side panel 900mm – SHSID90F

CODE	SIZE	ADJUSTMENT (A)
SHBIF76F	760mm	724 - 764mm
SHBIF80F	800mm	764 - 804mm
SHBIF90F	900mm	864 - 904mm

CODE	ENTRY	DOOR SWING (B)
SHBIF76F	508mm	422mm
SHBIF80F	560mm	442mm
SHBIF90F	625mm	495mm

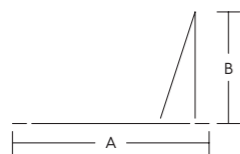

MBox Sliding Shower Door
MBS1000



MERLYN

The Merlyn MBox Sliding Shower Door is manufactured from 6mm toughened glass and is reversible.

Features & Benefits

- 1900mm high
- Reversible
- Magnetic seals
- Mershield protected glass
- Chrome design handle
- 20mm adjustment at each wall junction

Finish

- Polished silver effect frame

Material

- 6mm clear toughened glass

Compatible products

- MBox shower side panel 760mm – MBSP760
- MBox shower side panel 800mm – MBSP800
- MBox shower side panel 900mm – MBSP900

CODE	SIZE (C)	ADJUSTMENT(A)
MBS1000	1000mm	950 - 990mm
MBS1100	1100mm	1050 - 1090mm
MBS1200	1200mm	1150 - 1190mm
MBS1300	1300mm	1250 - 1290mm
MBS1400	1400mm	1350 - 1390mm
MBS1500	1500mm	1450 - 1490mm
MBS1600	1600mm	1550 - 1590mm
MBS1700	1700mm	1650 - 1690mm

CODE	ENTRY (A)	FIXED PANEL (B)
MBS1000	367mm	430mm
MBS1100	147mm	480mm
MBS1200	147mm	530mm
MBS1300	517mm	580mm
MBS1400	567mm	630mm
MBS1500	567mm	730mm
MBS1600	567mm	830mm
MBS1700	567mm	930mm

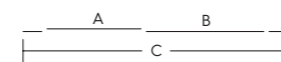

Sandringham 21 1700 x 700mm Water Saving Steel Bath – 2TH S183901



Armitage Shanks Sandringham 21 Water Saving Bath has a low capacity of 130ltrs to promote water saving.

Features & Benefits

- Single ended
- 130ltr capacity to overflow
- Two pre-drilled tap holes
- Chrome plated grips
- Anti-slip

Material

- Porcelain enamelled steel

Compatible products

- Nisa 1700mm front bath panel – S091501
- Nisa 700mm end bath panel – S091601
- 1½" combination bath waste and trap – S8840AA
- 1½" plastic P trap – S897067

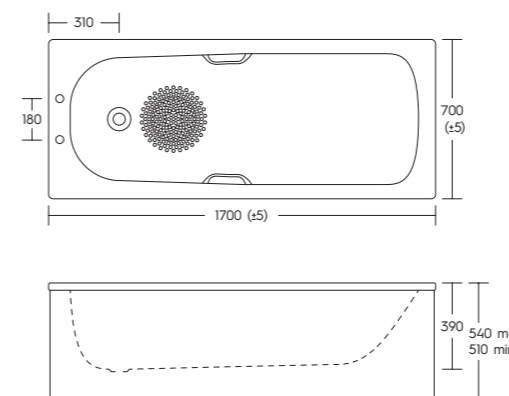

Anti slip is a resistant finish that reduces the chances of slipping, it does not prevent all slipping. Not suitable in areas involving the use of special chemicals.

Sandringham 21 1700 x 700mm Steel Bath – 2TH S183501



Armitage Shanks Sandringham 21 Steel Bath, with chrome plated grips and two tap holes offers a contemporary anti-slip modern design.

Features & Benefits

- Single ended
- 156ltr capacity to overflow
- Two pre-drilled tap holes
- Chrome plated grips
- Anti-slip

Material

- Porcelain enamelled steel

Compatible products

- Nisa 1700mm front bath panel – S091501
- Nisa 700mm end bath panel – S091601
- 1½" combination bath waste and trap – S8840AA
- 1½" plastic P trap – S897067

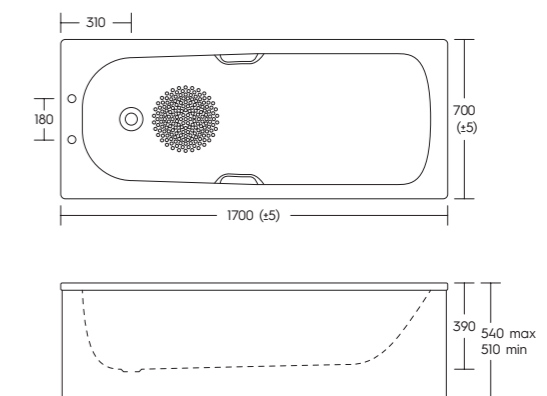

Anti slip is a resistant finish that reduces the chances of slipping, it does not prevent all slipping. Not suitable in areas involving the use of special chemicals.

Concept 1700 x 750mm Bath – 2TH
E729901



Ideal Standard

Ideal Standard Concept 1700 x 750mm double ended bath with central waste is both modern and stylish.

Features & Benefits

- Double ended
- 200ltr capacity to overflow
- Two pre-drilled tap holes
- Ergonomic back rests

Material

- Acrylic

Compatible products

- Unilux 1700mm front bath panel – E319401
- Unilux 750mm end bath panel – E319501
- Pop up bath waste – E1486AA

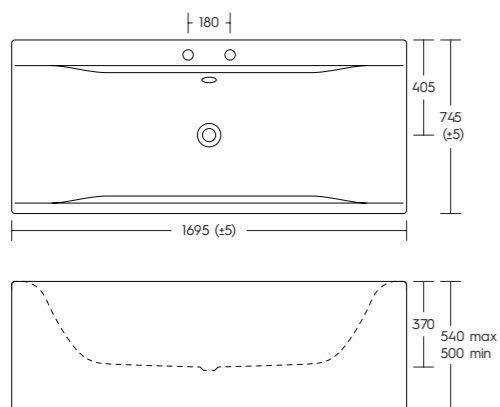

Radius Bath Screen
BTHSC101



SanCeram

Our stylish, SanCeram 850mm Radius Bath Screen is manufactured from toughened glass and is ideal for any bathroom project.

Features & Benefits

- 1500mm high with 20mm adjustment
- Reversible design
- Aquagleam on glass for easy cleaning

Swing into room

- 775mm

Material

- 6mm clear toughened glass

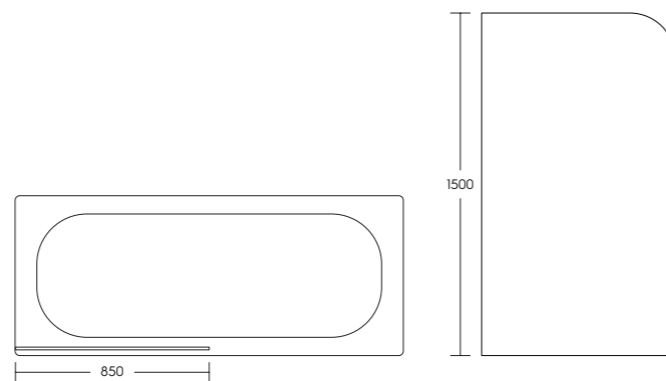

Fixed Square Bath Screen
MBO



MERLYN™

Merlyn Fixed Square Bath Screen manufactured from 6mm toughened safety glass, combines clean lines and watertight practicality and will make a modern addition to any bathroom.

Features & Benefits

- 1500mm high
- Reversible design
- Frameless screen
- Mershield Stayclear glass coating

Material

- 6mm clear toughened glass

Finish

- Chrome

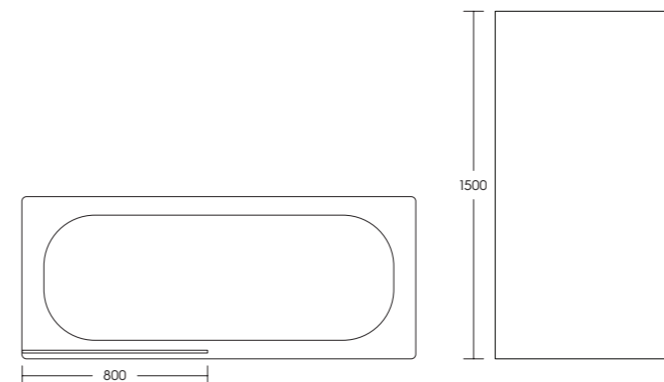

4 Fold Bath Screen
MB4



MERLYN™

Merlyn 4 Fold Bath Screen, manufactured from 4mm toughened safety glass is ideal for bathrooms with restricted space, folding away neatly and horizontally flush to the wall.

Features & Benefits

- 1400mm high
- Reversible
- Four moving glass panels
- Mershield Stayclear glass coating

Material

- 4mm clear toughened glass

Finish

- Chrome

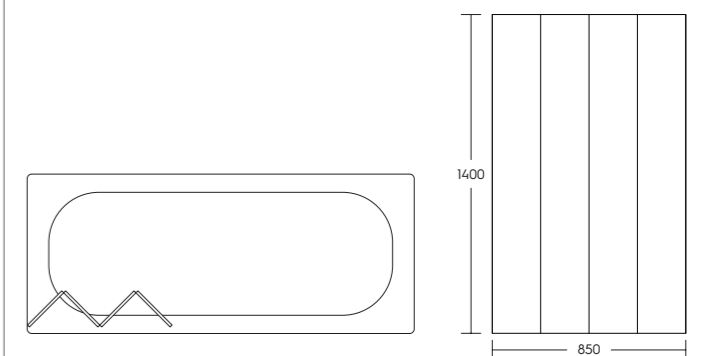

Plastic Lockable Mini Jumbo Toilet Roll Holder 0302538



SanCeram

Features & Benefits

- Capacity viewing window
- Finished in white
- Comes with a fixing kit for solid wall installations

Paper

- Un-perforated jumbo rolls with a max width of 110mm and between 45mm and 65mm core

Capacity

- 260mm max roll diameter

Material

- ABS

Recommended Installation Height

- 750mm from floor

Eco Automatic Warm Air Dryer 0302533



SanCeram

Features & Benefits

- Ideal for washrooms where hygiene is paramount
- Compact high speed
- Infra-red fully automatic
- Includes fixings for hard wall installation

Operating Voltage

- 220 - 240V 50Hz

Sound Level

- 70 dba at 1 meter from air outlet

Recommended Installation Height

- 1250mm from floor

Product Options

- White – 0302533
- Silver – 0302535



Plastic Push Action Liquid Soap Dispenser 0302540



SanCeram

Features & Benefits

- For liquid soap
- Capacity viewing window
- ABS in white
- Hard-wearing and durable
- Includes fixing for solid wall installation

Material

- ABS

Capacity

- 900ml refillable reservoir

Recommended Installation Height

- 1050 - 1150mm from floor
- 170 - 300mm from basin/vanity top level



Doc M

White Metal Warm Air Dryer 0302005



SanCeram

Features & Benefits

- Ideal for washrooms where hygiene is paramount
- Infra-red fully automatic, no touch
- Includes fixing for solid wall installation

Operating Voltage

- 220 - 240V 50/60Hz

Sound Level

- 76 dba at 1 meter from air outlet

Recommended Installation Height

- 1250mm from floor



Plastic Lockable Paper Towel Dispenser 0302537



SanCeram

Features & Benefits

- Capacity viewing window
- ABS in white finish
- Includes fixing for solid wall installation

Paper

- Interleaved c-fold or z-fold towels 65mm deep up to 255mm wide

Capacity

- 360mm max stack height

Material

- ABS

Recommended Installation Height

- 1300 - 1400mm from floor

Plastic Coat Hook 0300139

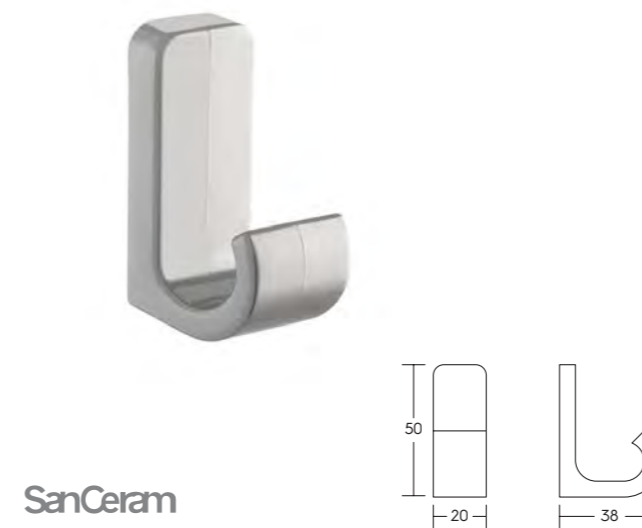

SanCeram

Features & Benefits

- Wall or panel mounted
- Includes fixings for a variety of wall/panel types

Material

- Nylon

Product Options

- Light grey – 0300139
- Dark grey – 0300137

Midi Jumbo Toilet Roll Dispenser
0302500

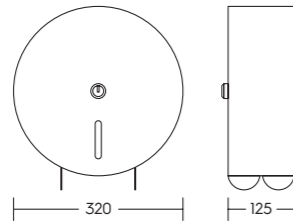

SanCeram

Features & Benefits

- Lockable
- Capacity viewing window
- Comes with a fixing kit for solid wall installations

Paper

- Un-perforated jumbo rolls with a max width of 100mm and 60mm core

Capacity

- 240mm max roll diameter

Material

- Stainless steel

Recommended Installation Height

- 750mm from floor

Product Options

- Stainless steel – 0302500
- White metal – 0302523

Turboforce Junior PLUS Hand Dryer
PL94MBS

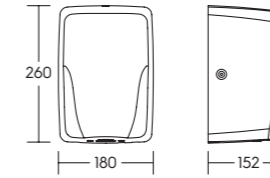

SanCeram

Features & Benefits

- Ideal for washrooms where hygiene is paramount
- Fast drying time with low energy consumption
- Perfect for smaller washrooms
- Internal UV protection for self-cleaning
- Includes fixings for hard wall installation

Operating Voltage

- 220 - 240V 50-60Hz

Sound Level

- 70 dba at 1 meter from air outlet

Recommended Installation Height

- 1250mm from floor



Lockable Stainless Steel Liquid Soap Dispenser
0302525

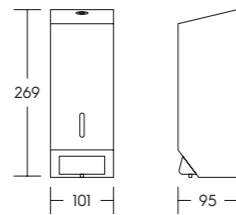

SanCeram

Features & Benefits

- Compatible with liquid soap
- Push action operation
- Stylish and durable
- Stainless steel with brushed satin finish
- Includes fixings for a variety of wall types

Paper

- Un-perforated jumbo rolls with a max width of 100mm and 60mm core

Capacity

- 1ltr refillable reservoir

Material

- Stainless steel

Recommended Installation Height

- 1050mm - 1150mm from floor
- 170mm - 300mm from basin/vanity top level

Hands In High Speed Hand Dryer
0302536

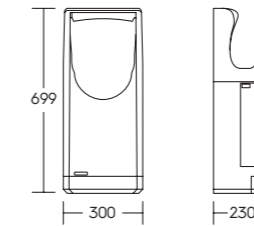

KWC DVS

Features & Benefits

- Automatic, no touch operation for increased hygiene
- Dries hands quicker and is quieter than conventional hand dryers
- Includes fixing for solid wall installation

Operating Voltage

- 220 - 240V 50/60Hz

Sound Level

- 65 dba at 1 meter

Recommended Installation Height

- 350mm from floor



Metal Lockable Paper Towel Dispenser
0302526

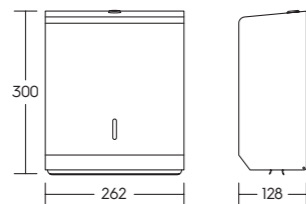

SanCeram

Features & Benefits

- Hinged cover with key lock access
- Visual display window
- Includes fixing for solid wall installation

Paper

- Interleaved c-fold or z-fold towels 75mm deep up to 255mm wide

Capacity

- 750 sheets

Material

- Stainless steel

Recommended Installation Height

- 1300 - 1400mm from floor

Stainless Steel Coat Hook - 65mm
CH65SWC

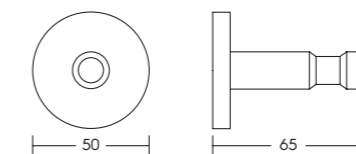

SanCeram

Features & Benefits

- Concealed fixings
- Rubber end stop
- Tested to 30kg

Material

- Stainless steel

Lockable Mini Jumbo Toilet Roll Dispenser 0302518

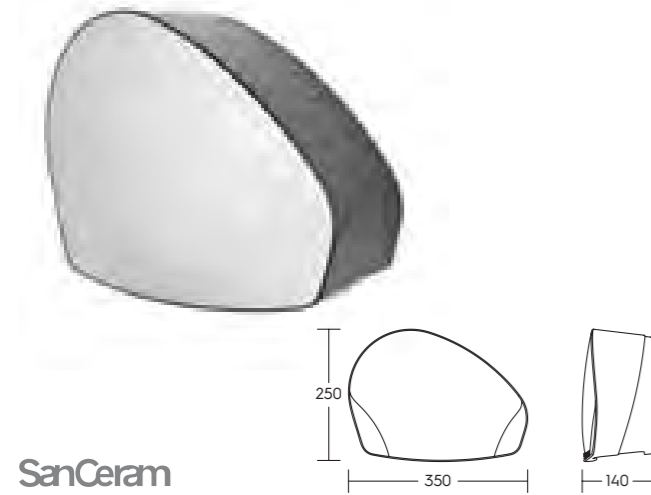

SanCeram

Features & Benefits

- Modern, light grey and brushed satin stainless steel finish
- Hard wearing and durable
- Comes with fixing kit for solid wall installation

Paper

- Perforated or un-perforated jumbo rolls with a max width of 110mm

Capacity

- 220mm max roll diameter

Material

- ABS and stainless steel

Recommended Installation Height

- 750mm from floor

Touch Free Liquid Sanitiser / Soap Dispenser AUTO20AAD

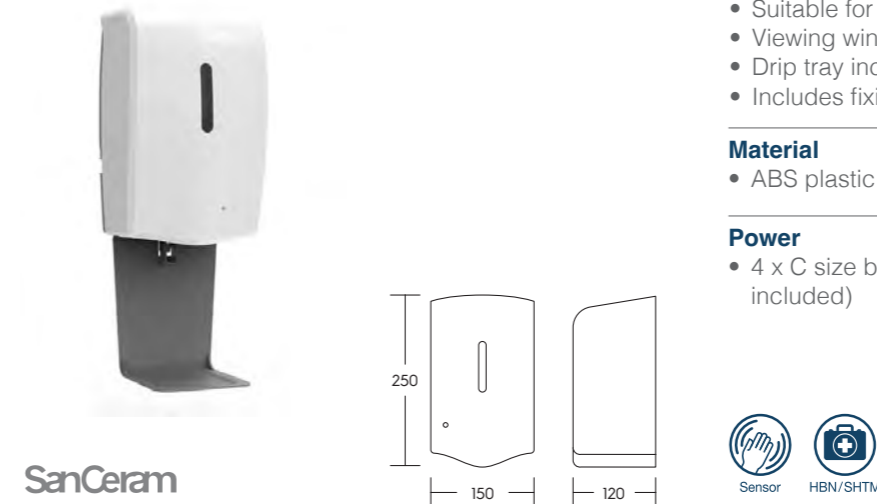

SanCeram

Features & Benefits

- Touch free, hygienic infrared sensor operation
- Dispenses liquid/sanitiser soap (0.6ml shot size)
- Suitable for most soaps and gels on the market
- Viewing window to check soap volume
- Drip tray included
- Includes fixing for solid wall installation

Material

- ABS plastic

Capacity

- 31000ml refillable reservoir

Power

- 4 x C size batteries (not included)

Compatible Products

- Freestanding floor mount – FS003

Lockable Push Action Soap Dispenser 0302513



SanCeram

Features & Benefits

- Compatible with liquid soap or foam soap
- Capacity viewing window
- ABS and brushed satin finish
- Includes fixing for solid wall installation

Product Options

- Liquid soap – 0302513
- Foam soap – 0302514

Capacity

- 900ml refillable reservoir

Material

- ABS and stainless steel

Recommended Installation Height

- 1050mm - 1150mm from floor
- 170mm - 300mm from basin/vanity top level

Stainless Steel Single Bottle Holder PL03MBS



SanCeram

Features & Benefits

- Designed to hold 1 x 250/300ml hand soap bottle
- Key lockable
- Fixing kit and adjustable back plate included

Material

- Stainless steel – 304L grade

Product Options

- Double holder also available – PL04MBS

Lockable Multiflat Toilet Tissue Dispenser 0302517



SanCeram

Features & Benefits

- Light grey and brushed satin stainless steel finish
- Comes with a fixing kit for solid wall installation

Paper

- Multiflat or flat pack toilet tissue up to 125mm in width

Capacity

- 220mm max stack height

Material

- ABS and stainless steel

Recommended Installation Height

- 1000mm from floor

Unisex WC Pictogram Door Sign 0302565



SanCeram

Features & Benefits

- Self-adhesive fixing
- Stainless steel with brushed finish

Material

- Stainless steel

Fixings

- Self adhesive

Product Options

- Unisex – 0302565
- Baby Change – 0302567

- Female – 0302564
- Male – 0302563
- Wheelchair accessible – 0302566

Why choose SanCeram?



Cost Effective
Savings of up to 40%



25 Year Warranty
Our ceramics come with a 25 year warranty



Approved & Certified
SanCeram contains HBN, DDA, WRAS approved and LABC certified products



Contemporary Styling
Inspired, modern designs without compromising on quality



Specification Support
We are on hand to offer support through our free NBS writing service



Technical Support
Dedicated technical team to offer support and advice throughout the project



Speedy Delivery
Fast and efficient delivery, stocked items delivered within 48 hours



How we can help you

- Our friendly and experienced team will provide technical advice, offering the most suitable products for your project
- We can offer a variety of Sanitaryware options suited to all sectors and budgets, at great value
- We will ensure product compliance
- We can write bespoke specification documents and provide 2D CAD Blocks, BIM, Product Data Sheets and NBS Documents
- We will ensure we meet any tender return dates
- We will provide dedicated support throughout your project from initial quotation to delivery
- We'll break down your order and deliver products as per your project requirements

Get in touch today...

- Speak to our team on Tel: 01474 338300
- If you have an enquiry ready to price send it to quotes@theswc.co.uk
- If you would like a specification written send the details to quotes@theswc.co.uk

You can also view all of our products and buy online at www.theswc.co.uk

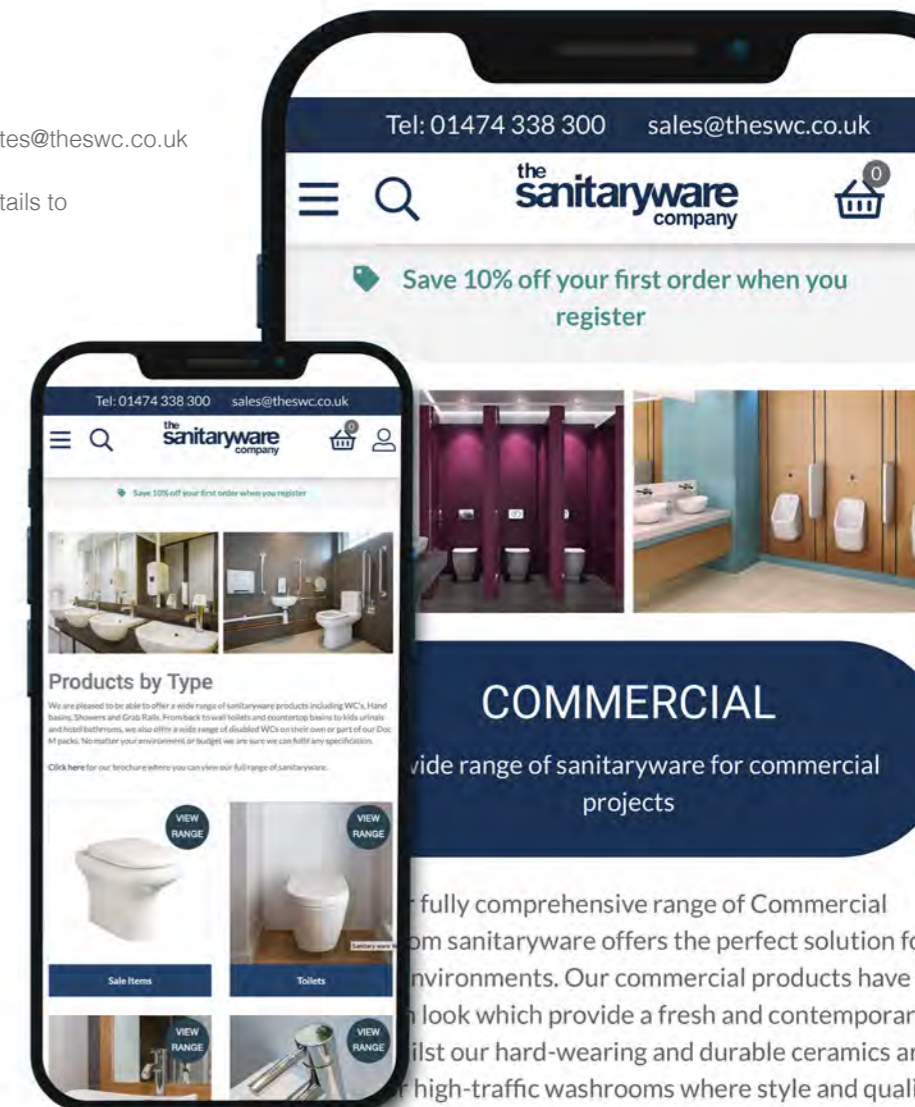

COMMERCIAL

Wide range of sanitaryware for commercial projects

A fully comprehensive range of Commercial sanitaryware offers the perfect solution for high-traffic washrooms where style and quality are of equal importance.

The aesthetics of an item may be a key consideration for commercial projects depending on the areas. For example a high end office project may consider this the most important factor in the decision on Sanitaryware

Unit 1400, Montegu Court
Kettering Parkway
Kettering
Northamptonshire
NN15 6XR

T 01474 338300
E sales@theswc.co.uk

www.theswc.co.uk



[Order online here](#)

the
sanitaryware
company

SanCeram

Disclaimer

All rights reserved. No part of this publication may be reproduced in any form or by any means, without the prior permission in writing of The Sanitaryware Company Limited or as expressly provided by law. The Sanitaryware Company Limited reserves the right to alter or change specifications without notice. Colours reproduced in this brochure are as accurate as the printing processes permit. All information is accurate at the time of publication. Please speak to our team for up to date information.